



TE'S CROMPTON INSTRUMENTS DIGITAL METERING SYSTEMS

Table of contents

I. Integra 12xx digital metering systems – panel mounted



Integra 1221 digital metering system	6
Integra 1221 Q2C wiring solution	8
Integra 1222 digital metering system	9
Q2C wiring solution	11
Integra 1232 digital metering system	14

II. Integra digital metering systems – DIN-rail mounted



Integra O230 digital metering system	18
Integra Ri3 digital metering system	20
Integra Ri4 digital metering system	22

III. Integra digital metering system - DIN-rail mounted with RJ12 wiring solution

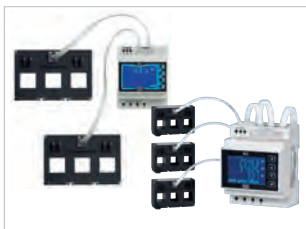

Integra SL1 single load multifunction metering system	26
Integra DL1 dual load multifunction metering system	28
Integra TL1 tri load multifunction metering system	31
DL 3-in-1 current transformers	33

IV. Integra 1630 and 1530 digital metering systems – panel mounted



Integra 1630 digital metering system	36
Integra 1530 digital metering system	39

V. Integra 2170 and 2270 power quality metering system



Integra 2170 power quality meter

44

Integra 2270 power quality meter

46

VI. Paladin advantage transducers



Transducer - 254 XZZ

50





Chapter I

Integra 12xx Digital metering systems – panel mounted

Integra 1221 digital metering system.....	6
Integra 1221 Q2C wiring solution	8
Integra 1222 digital metering system.....	9
Q2C wiring solutions.....	11
Integra 1232 digital metering system.....	14

Integra 1221 digital metering system

With an optional RJ12 wiring solution

FEATURES

- DIN 96 enclosure
- Backlit LCD screen
- Voltage IN-OUT connections
- CT current measurement 5A/1A
- Plug and socket connections
- Programmable VT, CT ratios
- Modbus™ RTU
- Individual harmonics to 63rd
- Non-volatile memory 1MB



APPROVALS

- IEC BS EN 61010-1:2010
- BS EN 61326-1:2013
- IEC 62053-21 Class 1
- IEC 62053-24 Class 1

BENEFITS

- Cost efficient
- Plug and socket connections
- Easy installation
- RJ12 wiring solution
- Made in the UK

DISPLAY

High definition screen features programmable backlight for high contrast visibility in low light and direct sunlight applications. The light can be programmed to automatically dim after set period of time for energy saving.

New “petal” array icons shows the percentage of full scale power of the measured system and the instantaneous power factor (PF) measurement gives clear PF indication. Total power consumption is displayed on the screen at all time.

RJ12 PLUG AND SOCKET WIRING SOLUTION

INTEGRA 1221 dms and the 3-in-1 current transformers include RJ12 plugs and sockets for easy connectivity and installation and the solution is available with wired looms to reduce assembly time and connection errors. IN-OUT voltage connections reduce wiring and installation time.

COMMUNICATION

Modbus RTU (RS485) available on all models. Two pulsed outputs available on self powered only.

PRODUCT CODES

Description	Part number
INTEGRA 1221 multifunction panel meter LCD Display. Input 480 V L-L 2 pulsed outputs, Modbus RS485 Self powered	INT-1221-S-010
INTEGRA 1221 multifunction panel meter LCD Display Input 480 V L-L Modbus RS485 Auxiliary powered	INT-1221-M-010

DISPLAYED PARAMETERS

- Voltage per phase L-N, L-L
- Current per phase and Max Demand
- Power Factor - per phase and system
- Total Harmonic Distortion – Voltage and Current per phase
- Neutral current
- Frequency system
- Phase Sequence
- Active Power (P) per phase, total and Max Demand
- Reactive Power (Q) per phase, total and Max Demand
- Apparent Power (S) per phase, total and Max Demand
- Energy – Active and Reactive Importing and Total
- Energy – Active and Reactive Exporting and Total

DIMENSIONS

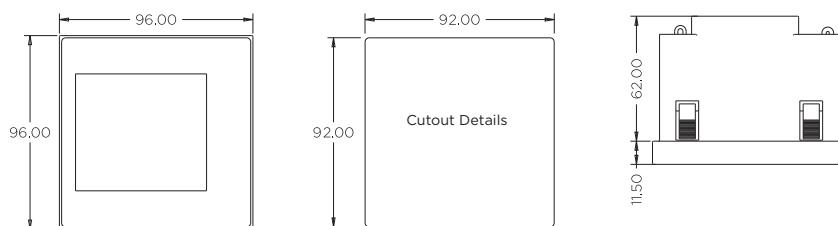

AUXILIARY AND SELF POWERED WIRING DIAGRAMS

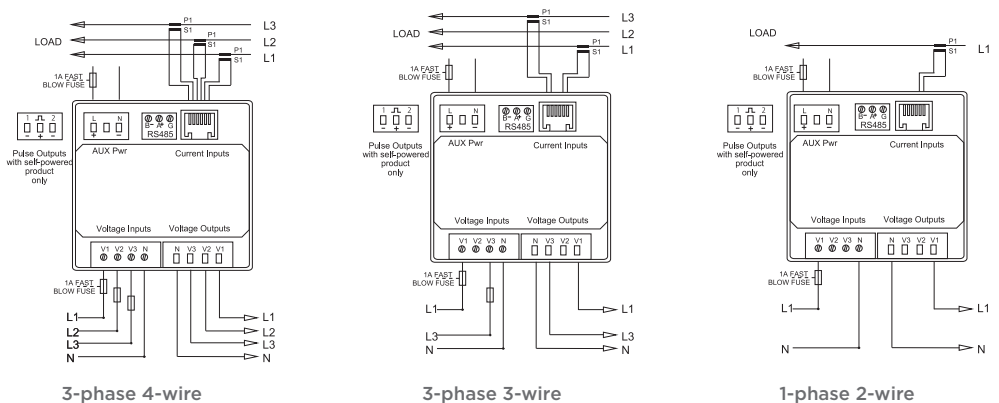

Integra 1221 digital metering system

PARAMETERS

Button	Scr	Parameter
ESC Ph S	1	Watts L1 Volts L1 Current L1 Active Energy L1
	2	Watts L2 Volts L2 Current L2 Active Energy L2
	3	Watts L3 Volts L3 Current L3 Active Energy L3
	4	Watts L1 Volts L1 Current L1 Reactive Energy L1
	5	Watts L2 Volts L2 Current L2 Reactive Energy L2
	6	Watts L3 Volts L3 Current L3 Reactive Energy L3
V/A	1	L-N Volts L1, L2, L3
	2	L-L Volts L1, L2, L3
	3	Current L1, L2, L3, N
	4	V-THD% per line
	5	I-THD% per line
	6	Phase Sequence V&I
MD PF Hz	1	PF and System Freq
	2	PF per phase
	3	MD per phase
	4	System Max demand P, Q, S.
P	1	Active Power (P) L1, L2, L3
	2	Reactive Power (Q) L1, L2, L3
	3	Apparent Power (S) L1, L2, L3
	4	System Powers P,Q,S
E	1	Imp Active Energy Exp Active Energy
	2	Imp Reactive Energy Exp Reactive Energy
	3	Total Active Energy Total Reactive Energy

SPECIFICATIONS

Input	
Nominal input voltage	57.7 – 276 V AC L-N (100-480 V L-L) 576 V L-L MAX
Max. continuous input overload voltage	120% of nominal
Max. short duration input voltage	2 x nominal voltage for 1 second
Nominal input voltage burden	< 0.2 VA per phase
Nominal input current	100 mA
Nom. Input current burden	< 0.1 VA
Max. continuous input overload current	120% of nominal
Max. short duration input current	20 x nominal current for 1 second
Auxiliary Powered	
Operating range	57.7-276 V L-N (100-480 L-L) AC/DC 50/60 Hz or Self powered from any phase
Supply burden	<5 VA
Accuracy	
Voltage (V)	+/- 0.5% of range maximum
Current (A)	+/- 0.5% of range maximum
Frequency (Hz)	+/- 0.2% of mid-frequency
Power factor (PF)	+/- 1% of unity (0.01)
Active power (W)	+/- 0.5% of reading
Reactive power (VAR)	+/- 0.5% of reading
Apparent power (VA)	+/- 0.5% of reading
Active energy (kWh)	+/- 0.5% of reading to IEC 62053-21
Reactive energy (kVARh)	+/- 0.5% of reading to IEC 62053-24
THD	2% to 63rd harmonic
Measured Range	
Voltage (V)	5 – 120% of nominal (Min 100 V – self powered)
Current (A)	5 – 120% of nominal
Frequency (Hz)	44 – 66 Hz
Power (W, VAR, VA)	5 – 144% of nominal (bi-directional)
Energy	8 digit, upto 9999999.9 MWh
Power factor	4 quadrant
THD	0 – 40% upto 63rd harmonic
Environment	
Operating temperature	-25°C to +70°C
Storage temperature	-40°C to +80°C
Relative humidity	0 to 95%, non-condensing
Shock	30 g in 3 planes
Vibration	10 Hz to 50 Hz, IEC 60068-2-6, 2 g
Surge voltage	4 kV (IEC 61000-4-5)
Impulse voltage	6 kV (IEC 60060-1)
Electromagnetic immunity	80 MHz - 2 GHz at 10 V/m IEC 61000-4-3
Electrostatic discharge	15 kV (IEC 61000-4-2)
Altitude	3000 m
Warm-up	1 minute
Outputs	
Pulsed outputs (self powered only)	Opto-coupled, potential-free SPST-NO contact
Contact rating current	50 mA at 230 V AC 27 mA at 27 V DC
Contact rating voltage	5 – 27 V DC
Pulse width	60/100/200 ms
Pulse rate	0.001/0.01 /0.1/1/10/100/1000 kWh/kVARh
Pulsed output relay (non-configurable)	2400IMP/kWh
Communications	
Type	2-wire half duplex
Baud rate	2400, 4800, 9600, 19200, 38400
Address	1 to 247
Enclosure	
Enclosure style	DIN 96 panel mount
Dimensions	96 x 96 x 62 mm
Panel cut-out	92 x 92 mm
Panel thickness	1-5 mm
Protection rating	Front IP54, Rear IP30, IP65 (with panel gasket)
Material	UL 94 – V0
Weight	340 g
Cable size	0.05 mm ² – 2.5 mm ² stranded wire
Terminals	Voltage and Current : Shrouded screw clamp

Integra 1221 Q2C wiring solution

FEATURES

- Complete wiring solution with integral RJ12 connectors
- Available with wired looms
- 3-in-1 current transformers with RJ12 connection
- CTs are supplied with fixing kit and 1.5 m cable with RJ12 connectors



BENEFITS

- Easy installation
- Reduced assembly time
- Eliminates connection errors

LOOMS PRODUCT CODE

Voltage Meter to Meter Loom

The meter to meter loom connects the voltage for upto 32 meters using high quality LSZH cable fitted with suitable plugs and socket for safe and easy voltage connections.



Part Number	Length
Q2C-VMM-0600-01	600 mm
Q2C-VMM-0900-01	900 mm
Q2C-VMM-1200-01	1200 mm
Q2C-VMM-1500-01	1500 mm
Q2C-VMM-2000-01	2000 mm
Other lengths available	

Voltage Meter to Open Loom

The meter to open loom connects the voltage supply from the fused connections to the meter using high quality LSZH cable fitted with suitable plugs and socket for safe and easy voltage connections.



Part Number	Length
Q2C-VFO-0600-01	600 mm
Q2C-VFO-1000-01	900 mm
Q2C-VFO-1200-01	1200 mm
Q2C-VFO-1500-01	1500 mm
Other lengths available	

CURRENT TRANSFORMERS PRODUCT CODES

Product Codes	Primary Current	VA at Class 1	VA at Class 0.5
DL3N1-35-60/0.1	60 A	0.25	-
DL3N1-35-125/0.1	125 A	0.5	0.25
DL3N1-35-160/0.1	160 A	0.35	0.25
DL3N1-35-250/0.1	250 A	0.5	0.25
DL3N1-45-250/0.1	250 A	0.25	-
DL3N1-45-400/0.1	400 A	-	0.25
DL3N1-45-600/0.1	600 A	-	0.25
DL3N1-70-400/0.1	400 A	-	0.25
DL3N1-70-600/0.1	600 A	-	0.25
DL3N1-70-800/0.1	800 A	-	0.25

Integra 1222 digital metering system

With an optional Q2C wiring solution

FEATURES

- DIN 96 enclosure
- Backlit LCD screen
- Voltage IN-OUT connections
- CT current measurement 5A/1A
- Plug and socket connections
- Programmable VT, CT ratios
- Modbus™ RTU
- Individual harmonics to 63rd
- Non-volatile memory 1MB



DISPLAYED PARAMETERS

- Voltage per phase L-N, L-L
- Current per phase and Max Demand
- Power Factor - per phase and system
- Total Harmonic Distortion - Voltage and Current per phase
- Neutral current
- Frequency system
- Phase Sequence
- Active Power (P) per phase, total and Max Demand
- Reactive Power (Q) per phase, total and Max Demand
- Apparent Power (S) per phase, total and Max Demand
- Energy - Active and Reactive Importing and Total
- Energy - Active and Reactive Exporting and Total

APPROVALS

- IEC BS EN 61010-1:2010
- BS EN 61326-1:2013
- IEC 62053-21 Class 0.5
- IEC 62053-24 Class 0.5

BENEFITS

- Cost effective
- Easy installation
- Q2C wiring solution
- Plug and socket connections
- Made in the UK

DISPLAY

High definition screen features programmable backlight for high contrast visibility in low light and direct sunlight applications. The light can be programmed to automatically dim after set period of time for energy saving.

New “petal” array icons shows the percentage of full scale power of the measured system and the instantaneous PF measurement gives clear PF indication. Total power consumption is displayed on the screen at all times.

Q2C WIRING SOLUTION

INTEGRA 1222 dms and the 3-in-1 current transformers feature Q2C wiring solution for simple yet fast installation utilising plug and socket connections and pre-cut wiring looms, which allow to reduce assembly time and connection errors. IN-OUT voltage connections reduce wiring and installation time.

COMMUNICATION

Modbus RTU (RS485) available on all models. Two pulsed outputs available on self powered only.

PRODUCT CODES

Description	Part number
INTEGRA 1222 multifunction panel meter LCD Display Input 480 V L-L 2 pulsed outputs, Modbus RS485 Self powered	INT-1222-S-010
INTEGRA 1222 multifunction panel meter LCD Display Input 480 V L-L Modbus RS485 Auxiliary powered	INT-1222-M-010

DIMENSIONS

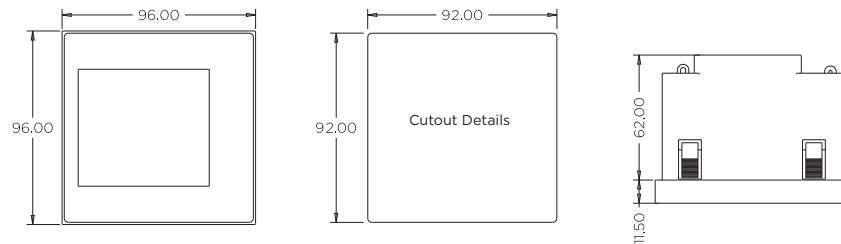

AUXILIARY AND SELF POWERED WIRING DIAGRAMS

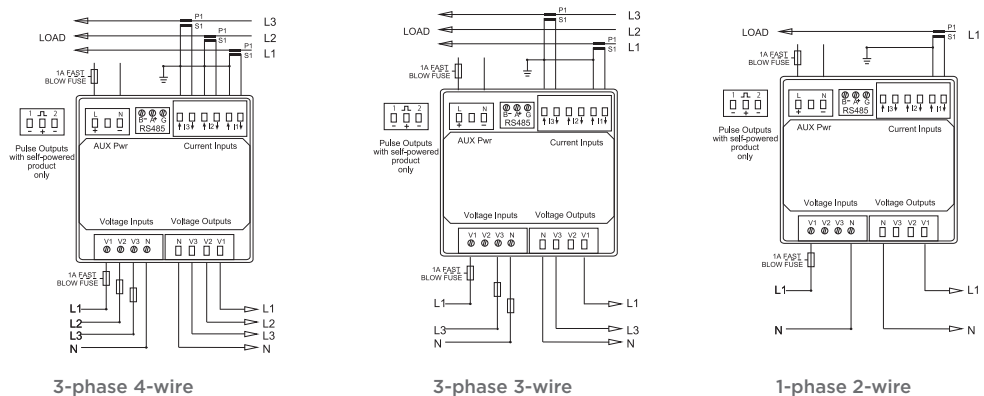

Integra 1222 digital metering system

PARAMETERS

Button	Scr	Parameter
ESC Ph S	1	Watts L1 Volts L1 Current L1 Active Energy L1
	2	Watts L2 Volts L2 Current L2 Active Energy L2
	3	Watts L3 Volts L3 Current L3 Active Energy L3
	4	Watts L1 Volts L1 Current L1 Reactive Energy L1
	5	Watts L2 Volts L2 Current L2 Reactive Energy L2
	6	Watts L3 Volts L3 Current L3 Reactive Energy L3
V/A	1	L-N Volts L1, L2, L3
	2	L-L Volts L1, L2, L3
	3	Current L1, L2, L3, N
	4	V-THD% per line
	5	I-THD% per line
	6	Phase Sequence V&l
MD PF Hz	1	PF and System Freq
	2	PF per phase
	3	Max Current Demand per phase
	4	System Max demand P, Q, S.
P	1	Active Power (P) L1, L2, L3
	2	Reactive Power (Q) L1, L2, L3
	3	Apparent Power (S) L1, L2, L3
	4	System Powers P,Q,S
E	1	Imp Active Energy Exp Active Energy
	2	Imp Reactive Energy Exp Reactive Energy
	3	Total Active Energy Total Reactive Energy

SPECIFICATIONS

Input	
Nominal input voltage	57.7 – 276 V AC L-N (100-480 V L-L) 576 V L-L MAX
Max. continuous input overload voltage	120% of nominal
Max. short duration input voltage	2 x nominal voltage for 1 second
Nominal input voltage burden	< 0.2 VA per phase
Nominal input current	1 A AC or 5 A AC
Nom. Input current burden	< 0.1 VA
Max. continuous input overload current	120% of nominal
Max. short duration input current (300 msec)	20 x nominal current for 1 second
Auxiliary Powered	
Operating range	57.7-276 V L-N (100-480 L-L) AC/DC 50/60 Hz or Self powered from any phase
Supply burden	<5 VA
Accuracy	
Voltage (V)	+/- 0.5% of range maximum
Current (A)	+/- 0.5% of range maximum
Frequency (Hz)	+/- 0.2% of mid-frequency
Power factor (PF)	+/- 1% of unity (0.01)
Active power (W)	+/- 0.5% of reading
Reactive power (VAR)	+/- 0.5% of reading
Apparent power (VA)	+/- 0.5% of reading
Active energy (kWh)	+/- 0.5% of reading to IEC 62053-21
Reactive energy (kVARh)	+/- 0.5% of reading to IEC 62053-24
THD	2% to 63rd harmonic
Measured Range	
Voltage (V)	5 – 120% of nominal (Min 100 V – self powered)
Current (A)	5 – 120% of nominal
Frequency (Hz)	44 – 66 Hz
Power (W, VAR, VA)	5 – 144% of nominal (bi-directional)
Energy	8 digit, upto 9999999.9 MWh
Power factor	4 quadrant
THD	0 – 40% upto 63rd harmonic
Environment	
Operating temperature	-25°C to +70°C
Storage temperature	-40°C to +80°C
Relative humidity	0 to 95%, non-condensing
Shock	30 g in 3 planes
Vibration	10 Hz to 50 Hz, IEC 60068-2-6, 2 g
Surge voltage	4 kV (IEC 61000-4-5)
Impulse voltage	6k V (IEC 60060-1)
Electromagnetic immunity	80 MHz - 2 GHz at 10 V/m IEC 61000-4-3
Electrostatic discharge	15 kV (IEC 61000-4-2)
Altitude	3000 m
Warm-up	1 minute
Outputs	
Pulsed output relay (self powered only)	Opto-coupled, potential-free SPST-NO contact
Contact rating current	50 mA at 230 V AC 27 mA at 27 V DC
Contact rating voltage	5 – 27 V DC
Pulse width	60 / 100 / 200 ms
Pulse rate	0.001/0.01/0.1/1/ 0/100/1000 kWh/kVARh
Pulsed output relay (non-configurable)	2400IMP/kWh
Communications	Modbus RTU (RS485)
Type	2-wire half duplex
Baud rate	2400, 4800, 9600, 19200, 38400
Address	1 to 247
Enclosure	
Enclosure style	DIN 96 panel mount
Dimensions	96 x 96 x 62 mm
Panel cut-out	92 x 92mm
Panel thickness	1 – 5 mm
Protection rating	Front IP54, Rear IP30, IP65 (with panel gasket)
Material	UL 94-V0
Weight	340 g
Cable size	0.05 mm ² – 2.5 mm ² stranded wire
Terminals	Voltage and Current : Shrouded screw clamp
Display characters	6.2 mm

Q2C wiring solution

Ensure error free installation and reduces wiring time by 80%

FEATURES

- A complete wiring solution with integral connectors and earthing
- Screwless terminal connections, vibration proof and maintenance free

BENEFITS

- Reduced installation time
- Eliminates potential cost of errors in electrical connections or programming
- Tidy solution for cable management

Voltage Meter to Meter Loom

The meter to meter loom connects the voltage for upto 32 meters using high quality LSZH cable fitted with suitable plugs and socket for safe and easy voltage connections.



Part Number	Length
Q2C-VMM-0600-01	600 mm
Q2C-VMM-1000-01	1000 mm
Q2C-VMM-1200-01	1200 mm
Q2C-VMM-1500-01	1500 mm
Q2C-VMM-2000-01	2000 mm

Other lengths available

Voltage Meter to Open Loom

The meter to open loom connects the voltage supply from the fused connections to the meter using high quality LSZH cable fitted with suitable plugs and socket for safe and easy voltage connections.



Part Number	Length
Q2C-VFO-0600-01	600 mm
Q2C-VFO-1000-01	1000 mm
Q2C-VFO-1200-01	1200 mm
Q2C-VFO-1500-01	1500 mm

Other lengths available

Current to Meter Loom

The current to meter loom connects the current from the current transformer to the current input on the meter using high quality LSZH cable fitted with suitable plugs and socket for safe and easy voltage connections.



Part Number	Length
Q2C-CTM-0600-01	600 mm
Q2C-CTM-0900-01	900 mm
Q2C-CTM-1200-01	1200 mm
Q2C-CTM-1500-01	1500 mm
Q2C-CTM-2000-01	2000 mm
Q2C-CTM-2500-01	2500 mm

Other lengths available

Current to Open Loom

The current to open loom connects the current transformer to the current inputs on the meters using high quality LSZH cable fitted with suitable plugs and socket for safe and easy voltage connections.



Part Number	Length
Q2C-CMO-0600-01	600 mm
Q2C-CMO-0900-01	900 mm
Q2C-CMO-1200-01	1200 mm
Q2C-CMO-1500-01	1500 mm
Q2C-CMO-2000-01	2000 mm
Q2C-CMO-2500-01	2500 mm

Other lengths available

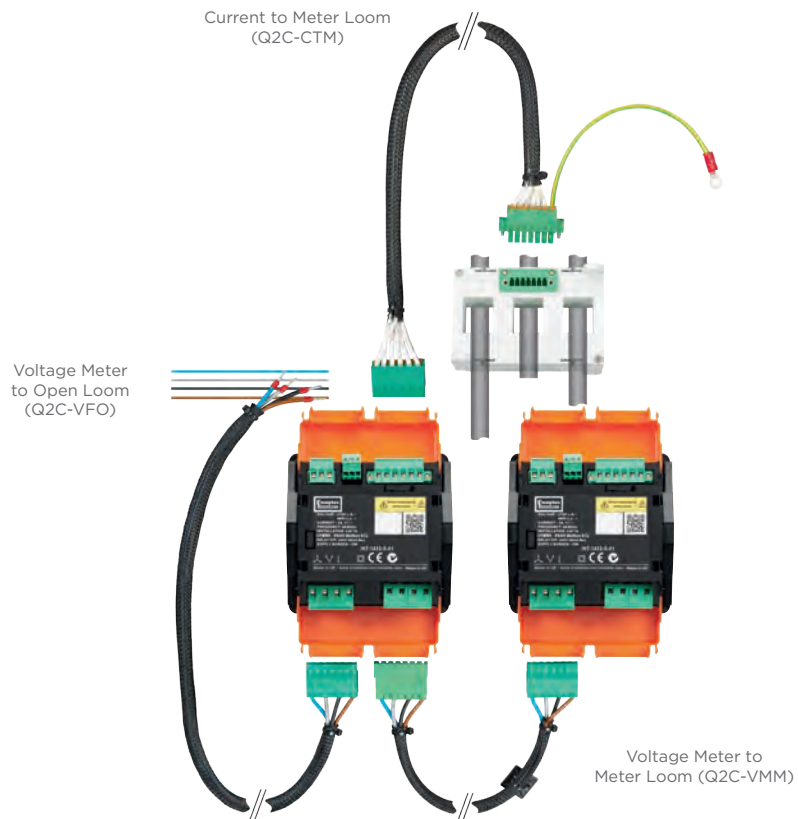

Q2C 3-in-1 current transformers

FEATURES

- Reversible mounting LHS and RHS
- Internal grounding/earthing facility
- Supplied with connector

BENEFITS

- Simple, easy and error free installation and wiring
- Applicable for most standard MCCB manufacturers



PRODUCT CODES

Part number	Ratio	Burden VA against class index			Aperture (mm)
		Class 0.5	Class 1	Class 3	
QC3N1-25-60/5	60/5	-	1	2	3 @ 15 x 25 mm
QC3N1-25-100/5	100/5	-	1.5	2.5	3 @ 15 x 25 mm
QC3N1-25-125/5	125/5	-	1.5	2.5	3 @ 15 x 25 mm
QC3N1-25-160/5	160/5	1.5	1.5	2.5	3 @ 15 x 25 mm
QC3N1-35-100/5	100/5	-	1.5	2	3 @ 21 x 25 mm
QC3N1-35-125/5	125/5	-	1.5	2.5	3 @ 21 x 25 mm
QC3N1-35-160/5	160/5	1.5	1.5	2.5	3 @ 21 x 25 mm
QC3N1-35-250/5	250/5	1.5	1.5	2.5	3 @ 21 x 25 mm
QC3N1-45-250/5	250/5	-	2.5 VA	-	3 @ 32 x 27 mm
QC3N1-45-400/5	400/5	-	2.5 VA	-	3 @ 32 x 27 mm
QC3N1-45-630/5	630/5	2.5 VA	5 VA	-	3 @ 32 x 27 mm
QC3N1-70-400/5	400/5	-	2.5 VA	-	3 @ 52 x 40 mm
QC3N1-70-630/5	630/5	2.5 VA	2.5 VA	-	3 @ 52 x 40 mm
QC3N1-70-800/5	800/5	2.5 VA	5 VA	-	3 @ 52 x 40 mm

DIMENSIONS

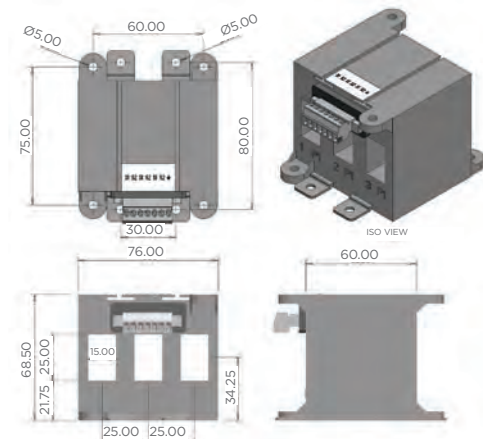

Qc3n1-25

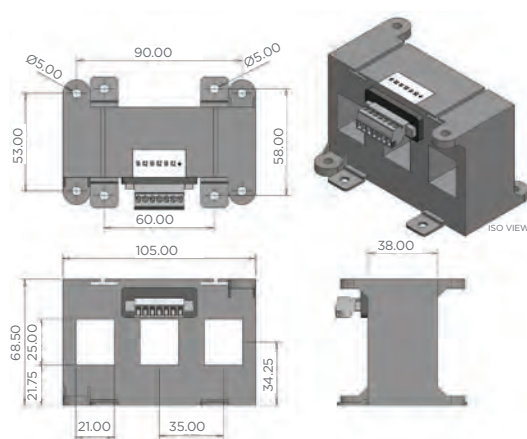

Qc3n1-35

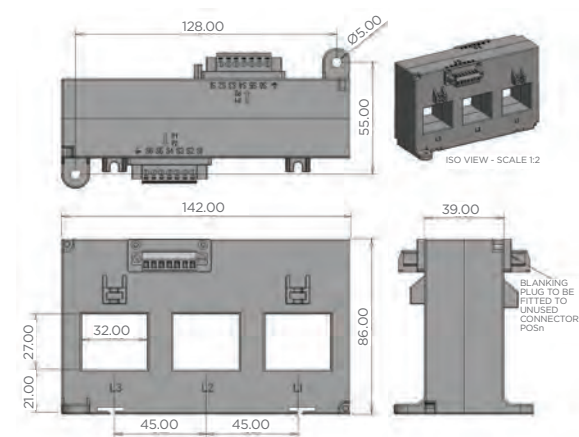

Qc3n1-45

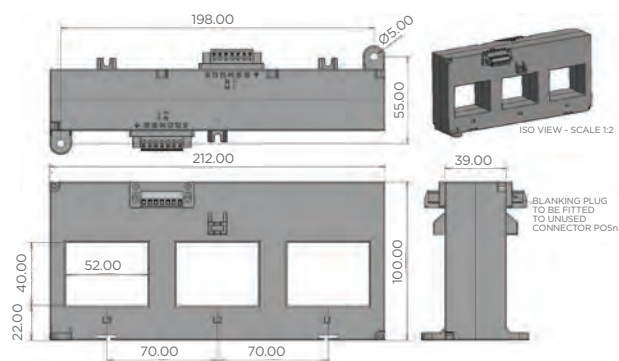

Qc3n1-70

3-in-1 current transformers

FEATURES

- Cost effective three-phase moulded case
- Ratio's ranging from 60/5 to 630/5
- Integrated wire sealable terminal cover
- Busbar, DIN-rail and metal feet mounting hardware supplied
- Combined M4 posi/slot screw

BENEFITS

- Isolated output for safety
- Faster installation
- Compact size
- Ex-stock delivery



A range of 3-in-1 current transformers combine three traditional current transformers in one moulded case. 3-in-1 current transformers can be directly installed next to a three-phase moulded case circuit breaker, thus saving installation time where fitting three standard individual current transformers would be required. The M3N1 range of current transformers offers primary currents between 60-630A with 5A secondaries with up to Class 0.5 accuracy performance.

PRODUCT CODES

Part number	Ratio	Burden VA against class index			Aperture (mm)
		Class 0.5	Class 1	Class 3	
M3N1-25-60/5	60/5	-	1	2	3 @ 15 x 25 mm
M3N1-25-100/5	100/5	-	1.5	2.5	3 @ 15 x 25 mm
M3N1-25-125/5	125/5	-	1.5	2.5	3 @ 15 x 25 mm
M3N1-25-160/5	160/5	1.5	1.5	2.5	3 @ 15 x 25 mm
M3N1-35-100/5	100/5	-	1	2	3 @ 21 x 25 mm
M3N1-35-125/5	125/5	-	1.5	2.5	3 @ 21 x 25 mm
M3N1-35-150/5	150/5	-	1.5	2.5	3 @ 21 x 25 mm
M3N1-35-160/5	160/5	1.5	1.5	2.5	3 @ 21 x 25 mm
M3N1-35-200/5	200/5	1.5	1.5	2.5	3 @ 21 x 25 mm
M3N1-35-250/5	250/5	1.5	1.5	2.5	3 @ 21 x 25 mm
M3N1-45-250/5	250/5	1.5	1.5	2.5	3 @ 31 x 31 mm
M3N1-45-300/5	300/5	2.5	2.5	3.75	3 @ 31 x 31 mm
M3N1-45-400/5	400/5	2.5	2.5	3.75	3 @ 31 x 31 mm
M3N1-45-500/5	500/5	2.5	2.5	3.75	3 @ 31 x 31 mm
M3N1-45-600/5	600/5	2.5	2.5	3.75	3 @ 31 x 31 mm
M3N1-45-630/5	630/5	2.5	2.5	3.75	3 @ 31 x 31 mm

DIMENSIONS

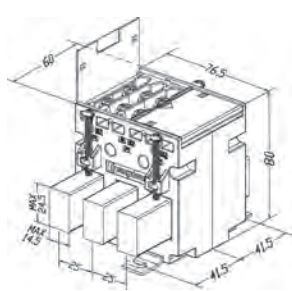

M3n1-25

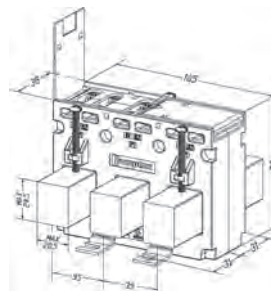

M3n1-35

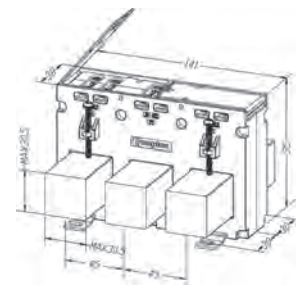

M3n1-45

Integra 1232 digital metering system

MID approved DMS with an optional Q2C wiring solution

FEATURES

- MID approved
- Programmable backlit LCD screen
- Voltage IN-OUT connections
- CT current measurement 5 A/1 A
- Plug and socket connections
- Programmable VT, CT ratios
- Modbus™ RTU
- 2 pulsed outputs with led indication
- PF bar indicator
- 3P4W, 3P3W, 1P2W system types
- Individual harmonics to 63rd



DISPLAYED PARAMETERS

- Voltage per phase L-N, L-L
- Current per phase and Max Demand
- Power Factor - per phase and system
- Total Harmonic Distortion - Voltage and Current per phase
- Neutral current
- Frequency system
- Phase Sequence
- Active Power (P) per phase, total and Max Demand
- Reactive Power (Q) per phase, total and Max Demand
- Apparent Power (S) per phase, total and Max Demand
- Energy - Active and Reactive Importing and Total
- Energy - Active and Reactive Exporting and Total

APPROVALS

- IEC BS EN 61010-1:2010
- BS EN 61326-1:2013
- IEC 62053-21 Class 0.5
- IEC 62053-24 Class 0.5

BENEFITS

- Cost effective
- Easy installation
- Q2C wiring solution

DISPLAY

High definition screen features programmable backlight for high contrast visibility in low light and direct sunlight applications. The light can be programmed to automatically dim after set period of time for energy saving.

New “petal” array icons shows the percentage of full scale power of the measured system and the instantaneous PF measurement gives clear PF indication. Total power consumption is displayed on the screen at all times.

The DIN 96 enclosure includes integral panel mounting clips for quick and easy fitting and the range includes single-phase, three-phase three-wire and three-phase four-wire capability, all selectable at the point of installation.

PRODUCT CODES

Description	Part number
INTEGRA 1232 multifunction panel meter LCD Input 480 V L-L, 5 A / 1 A AC Modbus RS485 Self-powered	INT-1232-S-01
Integra 1232 multifunction panel meter LCD Input 480 V L-L, 5 A / 1 A AC Modbus RS485 Auxiliary powered	INT-1232-M-01

DIMENSIONS

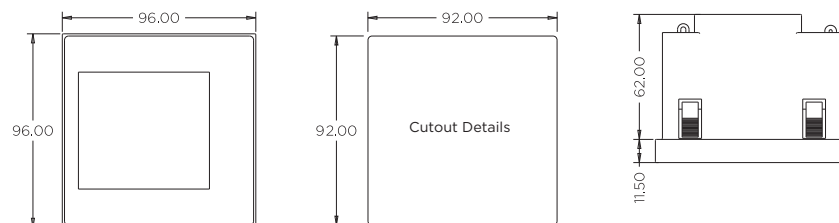

WIRING DIAGRAMS

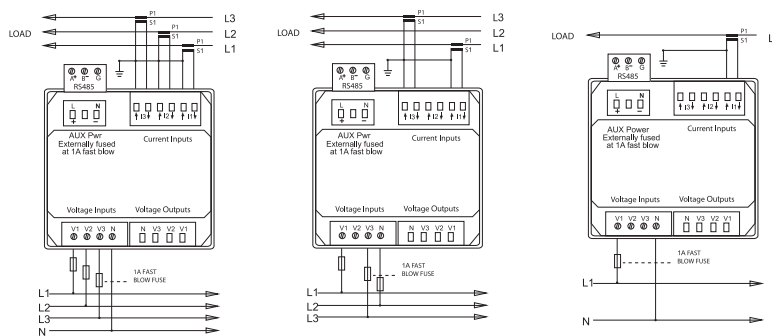

3-phase 4-wire

3-phase 3-wire

1-phase 2-wire

Integra 1232 digital metering system

PARAMETERS

Button	Scr	Parameter
ESC Ph S	1	Watts L1 Volts L1 Current L1 Active Energy L1
	2	Watts L2 Volts L2 Current L2 Active Energy L2
	3	Watts L3 Volts L3 Current L3 Active Energy L3
	4	Watts L1 Volts L1 Current L1 Reactive Energy L1
	5	Watts L2 Volts L2 Current L2 Reactive Energy L2
	6	Watts L3 Volts L3 Current L3 Reactive Energy L3
V/A	1	L-N Volts L1, L2, L3
	2	L-L Volts L1, L2, L3
	3	Current L1, L2, L3, N
	4	V-THD% per line
	5	I-THD% per line
	6	Phase Sequence V&I
MD PF Hz	1	PF and System Freq
	2	PF per phase
	3	Max Current Demand per phase
	4	System Max demand P, Q, S.
P	1	Active Power (P) L1, L2, L3
	2	Reactive Power (Q) L1, L2, L3
	3	Apparent Power (S) L1, L2, L3
	4	System Powers P,Q,S
E	1	Imp Active Energy Exp Active Energy
	2	Imp Reactive Energy Exp Reactive Energy
	3	Total Active Energy Total Reactive Energy

SPECIFICATIONS

Input	
Nominal input voltage	57.7 – 276 V AC L-N (100 – 480 V L-L) 576 V L-L MAX
Max. continuous input overload voltage	120% of nominal
Max. short duration input voltage	2 x nominal voltage for 1 second
Nominal input voltage burden	< 0.2 VA per phase
Nominal input current	1 A AC or 5 A AC
Nom. Input current burden	< 0.1 VA
Max. continuous input overload current	120% of nominal
Max. short duration input current (300 msec)	20 x nominal current for 1 second
Auxiliary	
Operating range	Self powered (from any of the three phases)
Auxiliary range	65 – 480 V AC / 80 – 600 V DC
Supply burden	< 10 VA
Accuracy	
Voltage (V)	+/- 0.5% of range maximum
Current (A)	+/- 0.5% of range maximum
Frequency (Hz)	+/- 0.2% of mid-frequency
Power factor (PF)	+/- 1% of unity (0.01)
Active power (W)	+/- 0.5% of reading
Reactive power (VAr)	+/- 0.5% of reading
Apparent power (VA)	+/- 0.5% of reading
Active energy (kWh)	+/- 0.5% of reading to IEC 62053-21
Reactive energy (kVArh)	+/- 0.5% of reading to IEC 62053-24
THD	2% to 63rd harmonic
Measured Range	
Voltage (V)	5 – 120% of nominal (Min 100 V – self powered)
Current (A)	5 – 120% of nominal
Frequency (Hz)	44 – 66 Hz
Power (W, VAr, VA)	5 – 144% of nominal (bi-directional)
Energy	8 digit, upto 9999999.9 MWh
Power factor	4 quadrant
THD	0 – 40% upto 63rd harmonic
Environment	
Operating temperature	-25°C to +55°C
Storage temperature	-40°C to +70°C
Relative humidity	0 to 95%, non-condensing
Shock	30 g in 3 planes
Vibration	10 Hz to 50 Hz, IEC 60068-2-6, 2 g
Dielectric Voltage	4 kV between voltage and current to earth
Altitude	3000 m
Warm-up	1 minute
Outputs	
Pulsed output relay (configurable)	Opto-coupled, potential-free SPST-NO contact
Contact Rating current	2 – 27 mA at 27 V DC
Contact Rating voltage	5 – 27 V DC
Pulse Width	60/100/200 ms
Pulse rate	0.001/0.01 /0.1/1/10/100/1000 kWh/kVArh
Pulsed output relay (non-configurable)	3200IMP/kWh
Communications	
Type	Modbus RTU (RS485)
Baud rate	2-wire half duplex
Address	2400, 4800, 9600, 19200, 38400
	1 to 247
Enclosure	
Enclosure Style	DIN 96 panel mount
Dimensions	96 x 96 x 62 mm
Panel cut-out	92 x 92 mm
Panel thickness	1 – 5 mm
Protection rating	Front IP54, Rear IP30
Material	UL 94-V0
Weight	340 g
Cable size	0.05 mm ² – 2.5 mm ² stranded wire
Terminals	Voltage and Current : Shrouded screw clamp
Display characters	6.2 mm

For Integra 1232 dms Q2C Wiring Solution see page 11. For Wiring diagrams see page 6.





Chapter 2 Integra digital metering systems – DIN-rail mounted

Integra 0230 digital metering system.....	18
Integra Ri3 digital metering system.....	20
Integra Ri4 digital metering system.....	22

Integra 0230 and 220 digital metering systems

MID approved digital metering system

FEATURES

- MID D certified
- DIN-rail enclosure DIN 43880
- Programmable backlit LCD screen
- CT current measurement 5 / 1 A
- Directly wired
- Programmable VT, CT ratios
- Modbus™ RTU as standard
- 2 pulsed outputs
- 3P4W, 3P3W, 1P2W system
- Individual harmonics to 31st



DISPLAYED PARAMETERS

- Voltage per phase L-N, L-L
- Current per phase and Max Demand
- Power Factor - per phase and system
- Total Harmonic Distortion - Voltage and Current per phase
- Neutral current
- Frequency system
- Phase Sequence
- Active Power (P) per phase, total and Max Demand
- Reactive Power (Q) per phase, total and Max Demand
- Apparent Power (S) per phase, total and Max Demand
- Energy - Active and Reactive Importing and Total
- Energy - Active and Reactive Exporting and Total

APPROVALS

- IEC BS EN 61010-1:2010
- BS EN 61326-1:2013
- IEC 62053-21 Class 1
- IEC 62053-24 Class 1

DISPLAY

High definition screen features programmable backlight for high contrast visibility in low light and direct sunlight applications. The light can be programmed to automatically dim after set period of time for energy saving.

AUXILIARY SUPPLY

Separate auxiliary input terminals are provided to power the product. Auxiliary output terminals are also provided to allow multiple products to be connected together. "Daisy-chain".

COMMUNICATION

Modbus RS485 RTU and two pulsed outputs are fitted as standard.

ENCLOSURE AND SYSTEM

The DIN-rail mounted enclosure includes integral retaining clip for quick and easy fitting and to suit user requirements, the range includes single-phase, three-phase three-wire and three-phase four-wire capability, all selectable at the point of installation.

BENEFITS

- Cost effective
- Easy installation
- Tamperproof

PRODUCT CODES

Description	Part number
Integra 0230 multifunction DIN-rail LCD Input 500 V L-L, 5 A / 1 A AC 2 pulsed outputs, Modbus RS485 MID Approved, auxiliary powered	INT-0230-S-01
Integra 0220 multifunction DIN-rail LCD Input 500 V L-L, 5 A / 1 A AC 2 pulsed outputs, Modbus RS485, auxiliary powered	INT-0220-S-01

DIMENSIONS

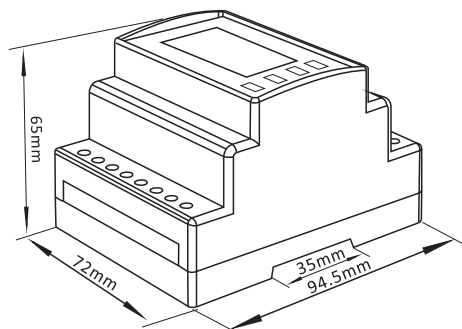

WIRING DIAGRAMS

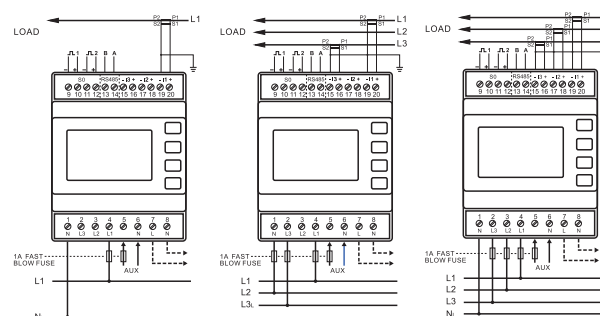

Integra O230 and 220 digital metering systems

PARAMETERS

Button	Scr	Parameter
	1	L-N Volts L1, L2, L3
	2	L-L Volts L1, L2, L3
	3	Current L1, L2, L3, N
	4	V-THD% per line
	5	I-THD% per line
	6	Phase Sequence V&I
	1	PF and System Freq
	2	PF per phase
	3	MD per phase
	4	System Max demand P, Q, S.
	1	Active Power (P) L1, L2, L3
	2	Reactive Power (Q) L1, L2, L3
	3	Apparent Power (S) L1, L2, L3
	4	System Powers P,Q,S
	1	Imp Active Energy Exp Active Energy
	2	Imp Reactive Energy Exp Reactive Energy
	3	Total Active Energy Total Reactive Energy

SPECIFICATIONS

Input	
Nominal input voltage	100 – 289 V AC L-N (65 – 500 V L-L) 600 V MAX
Max. continuous input overload voltage	120% of nominal
Max. short duration input voltage	2 x nominal voltage for 1 second
Nominal input voltage burden	< 0.2 VA per phase
Nominal input current 1/5A	1 / 5A
Nom. Input current burden	< 0.1 VA
Max. continuous input overload current	120% of nominal
Max. short duration input current	20 x nominal current for 1 second
Auxiliary	
Operating range	85 – 275 V AC 120 – 380 V DC
Supply burden	< 1 VA
Accuracy	
Voltage (V)	+/- 0.5% of range maximum
Current (A)	+/- 0.5% of range maximum
Frequency (Hz)	+/- 0.2% of mid-frequency
Power factor (PF)	+/- 1% of unity (0.01)
Active power (W)	+/- 1.0% of range maximum
Reactive power (VAR)	+/- 1.0% of range maximum
Apparent power (VA)	+/- 1.0% of range maximum
Active energy (kWh)	+/- 1.0% of range maximum to IEC 62053-21
Reactive energy (kVARh)	+/- 1.0% of range maximum to IEC 62053-24
THD	2% to 31st harmonic
Measured Range	
Voltage (V)	5 – 120% of nominal (Min 100 V – self powered)
Current (A)	5 – 120% of nominal
Frequency (Hz)	44 – 66 Hz
Power (W, VAR, VA)	5 – 144% of nominal (bi-directional)
Energy	8 digit, upto 9999999.9 MWh
Power factor	4 quadrant
THD	0 – 40% upto 63rd harmonic
Environment	
Operating temperature	-25°C to +55°C
Storage temperature	-40°C to +70°C
Relative humidity	0 to 95%, non-condensing
Shock	30g in 3 planes
Vibration	10 Hz to 50 Hz, IEC 60068-2-6, 2 g
Dielectric Voltage	4 kV between voltage and current to earth
Altitude	3000 m
Warm-up	1 minute
Outputs	
Pulsed output relay (configurable)	Opto-coupled, potential-free SPST-NO contact
Contact Rating current	2 – 27 mA at 27 V DC
Contact Rating voltage	5 – 27 V DC
Pulse Width	60/100/200 ms
Pulse rate	0.01 / 0.1 / 1 / 10 / 100 kWh/kVARh
Pulsed output relay (non-configurable)	3200IMP/kWh
Communications	
Type	Modbus RTU (RS485)
Type	2-wire half duplex
Baud rate	4800, 9600, 19200, 38400
Address	1 to 247
Enclosure	
Enclosure Style	DIN-rail to DIN 43880
Dimensions	72 x 94.5 x 62 mm
Protection rating	Front IP54, Rear IP30
Material	UL 94-V0
Weight	230 g
Cable size	0.05 mm – 4 mm stranded wire
Terminals	Voltage: Shrouded screw-clamp. Current: Shrouded screw clamp

Integra Ri3 digital metering system

FEATURES

- DIN-rail enclosure DIN 43880
- Backlit LCD screen
- Programmable CT ratio
- True rms measurement
- User programmable system configuration
- Pulsed output and Modbus RTU RS485 protocol as standard



APPROVALS

- IEC 61326
- IEC 61010-1
- IEC 62053-21

BENEFITS

- Cost effective
- Simple navigation
- Crompton renowned quality
- UK manufactured

The product features a DIN-rail enclosure, backlit LCD display and user programmable CT ratios, all accessible via an intuitive user interface. Integra Ri3 dms measures 17 electrical parameters including total harmonic distortion (THD) measurement up to the 31st harmonic.

PROGRAMMABLE FUNCTIONS

Integra Ri3 dms is programmable to suit single-phase, three-phase three-wire and three-phase four-wire system configurations. Programmable CT ratios enable to display any current range.

DISPLAY

The parameters can be viewed on a backlit LCD display. The 15 screens are accessible via four buttons on the front panel allowing to scroll between various screens making the navigation very user-friendly, intuitive and above all - simple.

OUTPUT

Modbus RTU RS485 protocol and pulsed output are available as standard.

PRODUCT CODES

Description	Part number
Integra Ri3 multifunction DIN-rail LCD Input 500 V L-L, 5 A AC 1 pulsed output. Modbus RTU RS 485, JC N2 Auxiliary powered	RI3-01

PARAMETERS

Button	Screen	Parameters
V/Hz	1	Volts L1 - N Volts L2 - N Volts L3 - N
	2	Volts L1 - L2 Volts L2 - L3 Volts L3 - L1
	3	Frequency
	4	Volts L1 - N THD% Volts L2 - N THD% Volts L3 - N THD%
	5	Volts L1 - L2 THD% Volts L2 - L3 THD% Volts L3 - L1 THD%
A	1	Current L1 Current L2 Current L3
	2	Neutral Current
	3	L1 Current Max Demand L2 Current Max Demand L3 Current Max Demand Neutral Current Max Demand
	4	Current L1 THD% Current L2 THD% Current L3 THD%
	5	
P/PF	1	kW kVA kVA
	2	kW Max Demand
	3	Power Factor
E	1	Import kWh
	2	Export kWh
	3	Import kVAh
	4	Export kVAh

PROGRAMMABLE PARAMETERS

Parameter	Range
Password	4-digit 0000-9999
System configuration	1-phase 2-wire, 3-phase 3-wire, 3-phase 4-wire
Demand integration time	OFF 5, 8, 10, 15, 20, 30, 60 minutes
CT primary current	Maximum 9999A **
3 independent resets	Demands and maximum demands
Communications	Modbus RTU RS 485 or JC N2
RS485 baud rate	2.4, 4.8, 9.6, 19.2, 38.4 kbps
RS485 parity and stop bits	Odd or even with 1 stop bit or no parity with 1 or 2 stop bits
RS485 Comms Address	1-247
Modbus word order	Normal or reverse
Pulse output allocation	Import or export kWh or import or export kVAh
Pulse rate, rate per pulse	0.001, 0.01, 0.1, 1, 10, 100, 1k, 10 k (max 2 pulses per sec)
Pulse output duration	60, 100, 200 milliseconds
Energy units	Unit, lilo or mega
Noise limit (1%)	On or off
Test	Display ON, TOGGLE or PHASE SEQUENCE

DIMENSIONS

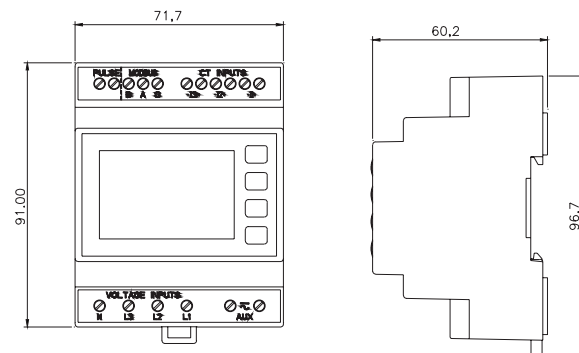

Integra Ri3 digital metering system

WIRING DIAGRAMS

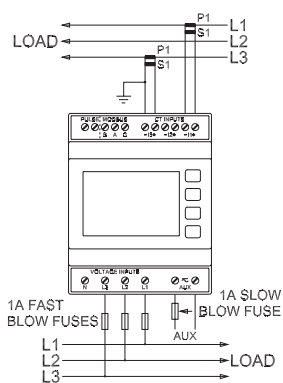

3-phase 3-wire

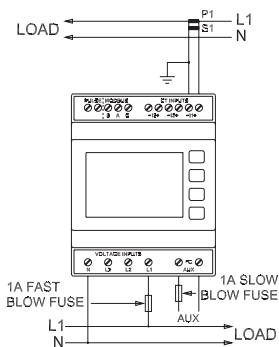

Single-phase 2-wire

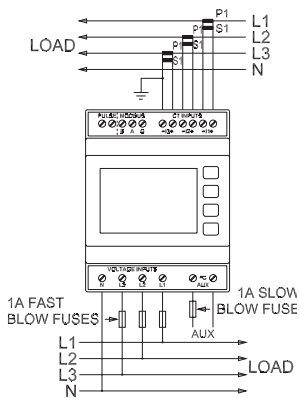

3-phase 4-wire

SPECIFICATIONS

Input	
Nominal input voltage	100 – 289 V AC L-N (173 – 500 V AC L-L)
Max. cont. input overload voltage	120% of nominal
Max. short duration input voltage	2 x range maximum (1 second application repeated 5 times at 5 minute intervals)
Nominal input voltage burden	< 0.2 VA per phase
Nominal input current	5 A AC rms
Max. cont. input overload current	120% of nominal
Max. short duration input current	10 x nominal (1 second application repeated 5 times at 5 minute intervals)
Nominal input current burden	< 0.6 VA per phase
Frequency	45 – 66 Hz
System CT primary values	1 to 9999
Auxiliary Operating range	
Operating range	Self powered (from any of the three phases)
Auxiliary range	65-480 V AC / 80-600 V DC
Supply burden	< 10 VA
Burden	< 10 VA/5 W
Accuracy Voltage (V)	0.5%
Current (A)	0.5%
Neutral current calculated (A)	4%
Frequency (Hz)	0.1 Hz
Power factor (PF)	1% of unity
Active power (W)	+/- 1% of range
Reactive power (VAR)	+/- 1% of range
Apparent power (VA)	+/- 1% of range
Active energy (kWh)	Class 1 (IEC 62053-21)
Reactive energy (kVARh)	+/- 1% of range
THD	1% up to 31st harmonic
Response time	1 sec
Output Pulse output relay	1
Contact rating	50 mA max at 250 V AC
Type	Solid state relay
Modbus RTU RS485 Protocol	1 Modbus RTU RS485 protocol channel output module
Type	2-wire half duplex
Baud rate	2400, 4800, 9600, 19200, 38400
Enclosure	
Enclosure style	DIN-rail - DIN 43880
Front protection rating	IP52
Case protection rating	IP30
Material	Polycarbonate to UL94V0
Weight	300 g
Terminals	Shrouded screw-clamp 0.05 - 4 mm wire
Environment	
Operating temperature	-10°C to +55°C
Storage temperature	-20°C to +70°C
Relative humidity	0-90% non-condensing
Shock	30 g in 3 planes
Vibration	10 Hz to 50 Hz
Dielectric voltage	Withstand test 3.25 kV rms 50 Hz for 1 minute between comms and measuring inputs, comm and aux, aux and measuring inputs

Integra Ri4 digital metering system

FEATURES

- 0.333 V AC input rms
- DIN-rail enclosure DIN 43880
- Backlit LCD screen
- Programmable CT ratio
- True rms measurements
- User programmable system configuration
- Import and Export kWh



APPROVALS

- IEC 61326
- IEC 61010-1
- IEC 62053-21

BENEFITS

- Cost effective
- Simple navigation
- Crompton renowned quality
- UK manufactured

The Integra Ri4 digital metering system (dms) voltage input of 0.333 volts AC makes it an ideal meter for energy monitoring applications while its compact DIN-rail enclosure allows space saving for retrofit applications.

The product features a DIN-rail enclosure, backlit LCD display and user programmable CT ratios, all accessible via an intuitive user interface. Integra Ri4 dms measures 17 electrical parameters including total harmonic distortion (THD) measurement up to the 31st harmonic.

PRODUCT CODES

Description	Part number
Integra Ri4 multifunction DIN-rail LCD Input 500 V L-L, 0.333 V AC 1 pulsed output. Modbus RTU RS 485, JC N2 Auxiliary powered	RI4-01

PARAMETERS

Button	Screen	Parameters
V/Hz	1	Volts L1 - N Volts L2 - N Volts L3 - N
	2	Volts L1 - L2 Volts L2 - L3 Volts L3 - L1
	3	Frequency
	4	Volts L1 - N THD% Volts L2 - N THD% Volts L3 - N THD%
	5	Volts L1 - L2 THD% Volts L2 - L3 THD% Volts L3 - L1 THD%
A	1	Current L1 Current L2 Current L3
	2	Neutral Current
	3	L1 Current Max Demand L2 Current Max Demand L3 Current Max Demand Neutral Current Max Demand
	4	Current L1 THD% Current L2 THD% Current L3 THD%
	5	
P/PF	1	kW kVAr kVA
	2	kW Max Demand
	3	Power Factor
E	1	kWh
	2	kVArh

PROGRAMMABLE PARAMETERS

Parameter	Range
Password	4-digit 0000-9999
System configuration	1-phase 2-wire, 3-phase 3-wire, 3-phase 4-wire
Demand integration time	OFF 5, 8, 10, 15, 20, 30, 60 minutes
CT primary current	Maximum 9999A **
3 independent resets	Demands and maximum demands
Communications	Modbus RTU RS 485 or JC N2
RS485 baud rate	2.4, 4.8, 9.6, 19.2, 38.4 kbps
RS485 parity and stop bits	Odd or even with 1 stop bit or no parity with 1 or 2 stop bits
RS485 Comms Address	1-247
Modbus word order	Normal or reverse
Pulse output allocation	Import or export kWh or import or export kVArh
Pulse rate, rate per pulse	0.001, 0.01, 0.1, 1, 10, 100, 1 k, 10 k (max 2 pulses per sec)
Pulse output duration	60, 100, 200 milliseconds
Energy units	Unit, lilo or mega
Noise limit (1%)	On or off
Test	Display ON, TOGGLE or PHASE SEQUENCE

DIMENSIONS

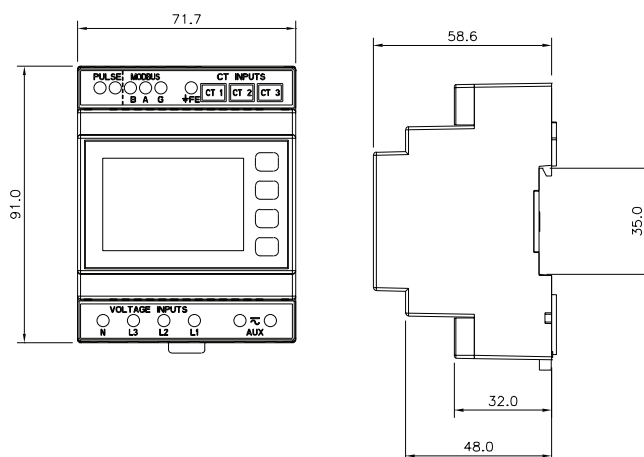

Integra Ri4 digital metering system

WIRING DIAGRAMS

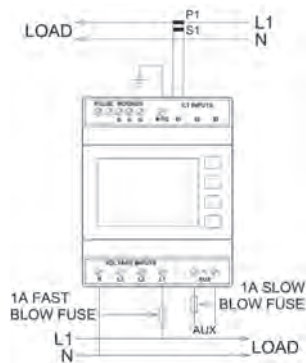

Single-phase, 2-wire

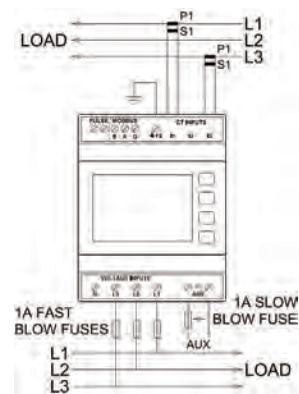

3-phase, 3-wire

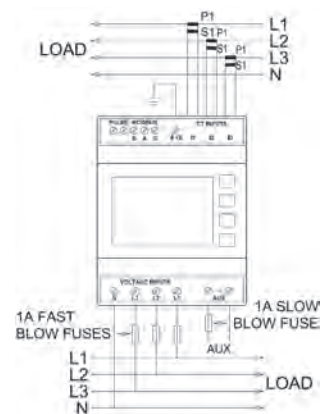

3-phase 4-wire

SPECIFICATIONS

Input	
Nominal input voltage	100 – 289 V AC L-N (173 – 500 V AC L-L)
Max. cont. input overload voltage	120% of nominal
Max. short duration input voltage	2 x range maximum (1 second application repeated 5 times at 5 minute intervals)
Nominal input voltage burden	< 0.2 VA per phase
Nominal input current	0.333 V (333 mV) AC rms
Max. cont. input overload current	120% of nominal
Max. short duration input current	10 x nominal (1 second application repeated 5 times at 5 minute intervals)
Frequency	45 – 66 Hz
Auxiliary Operating range	
	110 – 400 V AC nominal +/-10% (99 – 440 V AC absolute limits) or 120 – 350 V DC +/-20% (96 – 420 V DC absolute limits)
Accuracy Voltage (V)	0.5%
Current (A)	0.5%
Neutral current calculated (A)	4%
Frequency (Hz)	0.1 Hz
Power factor (PF)	1% of unity
Active power (W)	+/- 1% of range
Reactive power (VAr)	+/- 1% of range
Apparent power (VA)	+/- 1% of range
Active energy (kWh)	Class 1 (IEC 62053-21)
Reactive energy (kVArh)	+/- 1% of range
THD	1% up to 31st harmonic
Response time	1 sec
Output Pulse output relay	
	1 per module
Contact rating	50 mA max at 250 V AC
Type	Solid state relay
Modbus RTU RS485 Protocol	1 Modbus RTU RS485 protocol channel output module
Type	2-wire half duplex
Baud rate	2400, 4800, 9600, 19200, 38400
Enclosure	
Enclosure style	DIN-rail
Front protection rating	IP52
Case protection rating	IP30
Material	Polycarbonate to UL94V0
Weight	300 g
Terminals	Shrouded screw-clamp 0.05 - 4 mm wire
Environment	
Operating temperature	-10°C to +55°C
Storage temperature	-20°C to +70°C
Relative humidity	0-90% non-condensing
Shock	30 g in 3 planes
Vibration	10 Hz to 50 Hz
Dielectric voltage	Withstand test 3.25 kV rms 50 Hz for 1 minute between comms and measuring inputs, comm and aux, aux and measuring inputs





Chapter 3 Integra digital metering system - DIN-rail mounted with RJ12 wiring solution

Integra SL1 single load metering system.....	26
Integra DL1 dual load multifunction metering system.....	28
Integra TL1 tri load multifunction metering system.....	31
3-in-1 current transformer.....	33

Integra SL1 single load metering system

FEATURES

- Modbus RTU RS485 as standard
- User-programmable CT ratio and system configuration
- True rms measurement
- Continuous busbar or individual busbar metering

APPROVALS

- IEC 61326
- IEC 61010-1
- IEC 62053-21
- RoHS Compliant

BENEFITS

- Cost-effective
- UK manufactured
- CL0.5 accuracy
- Modbus communications
- Fully configurable
- Additional facility to accumulate the total system power/kWhs - displaying the combined system total parameters



Designed, developed and manufactured in the UK, the Integra SL1 is a digital metering system which provides measurement, isolation and conversion of all main electrical parameters from a three-phase load, in a single meter. It can be used in single and three-phase unbalanced four-wire electrical systems and as an accuracy of CL0.5.

The Integra SL1 has an integrated microprocessor for exceptional waveform handling of distorted waveforms, and is ideal for low voltage applications. It provides a cost effective way of metering split load distribution and panel boards, in a single metering solution.

PRODUCT CODES

Description	Part number
Integra SL1 multifunction DIN-rail LCD Input 400 V L-L, 100 mA AC Modbus RTU RS 485 Self powered	SL1-01

DISPLAYED PARAMETERS

Power (Load 1)
Current L1
Current L2
Current L3
kW L1
kW L2
kW L3
Average System Volts
Average System Current
Average System kW
kWh Import

DIMENSIONS

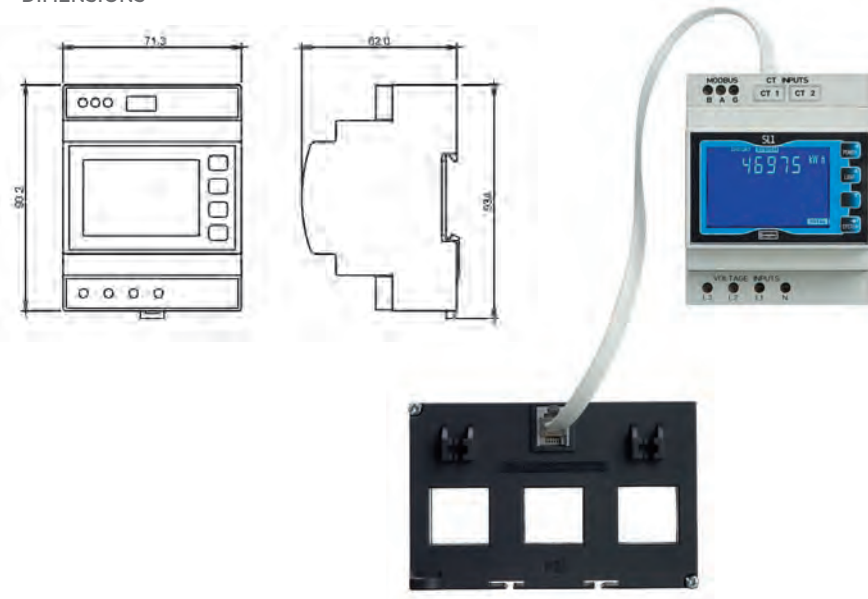

Integra SL1 single load metering system



WIRING DIAGRAMS

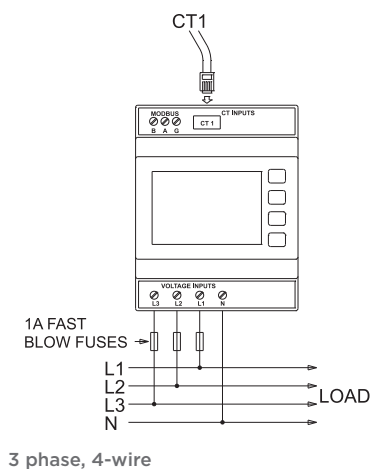
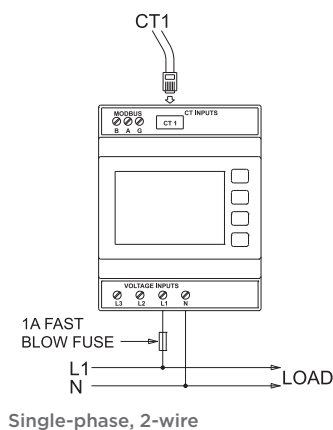

SPECIFICATION

Input	
Nominal input voltage	100 V to 230 V AC rms., L – N. 173 V to 400 V AC rms., L – L
Max. continuous input overload voltage	120% of nominal
Max. short duration input voltage (1 sec)	2 x nominal voltage
Nominal input voltage burden	0.2 VA per phase (Except L1)**Self powered using the meter electrical input from L1 (6VA)
Nominal input current	100 mA AC rms. per CT
System CT primary values	1-9999 A (selectable from display)
CT burden	0.1 VA
Accuracy	
Voltage (V)	< 0.5%
Current (A)	< 0.5%
Frequency (Hz)	< 0.2% of mid range
Power factor (PF)	1% of unity
Active power (W)	+/- 1.0% Class 1 IEC 62053-21
Active energy (kWh)	+/- 1.0% Class 1 IEC 62053-21
Range	
Voltage (V)	5% to 120% for nominal
Current (A)	5% to 120% of nominal
Frequency	45 – 65 Hz
Power	1 – 144% of nominal 0.8 capacitive – 1 – 0.8
Power factor	Inductive (functional 4 quadrant, 0-1 lag lead)
Energy	6-digit resolution and to be displayed in kWh (Maximum display 999999, before rollover to 0)
Outputs	
Communication protocol	RS485 Modbus RTU
Type	2-wire half duplex
Baud rate	9600, 19200, 38400
Enclosure	
Enclosure style	DIN-rail mounting EN43880
Dimensions	72 x 90 x 62 mm
Material	Polycarbonate to UL94-V0
Weight	0.25 kg
Terminals voltage	Shrouded screw-clamp 0.05 - 4 mm wire
Terminals CT	RJ12 connector
Sealing	IP52 front of panel
Environment	
Operating temperature	-10°C to +55°C
Storage temperature	-20°C to +70°C
Relative humidity	0-90% non-condensing
Shock	30 g in 3 planes and vibration of 0 Hz to 50 Hz IEC 60068-2-6, 2 g
Vibration	0 Hz to 50 Hz, IEC 60068-2-6, 2 g. Withstand test 2.2 kV, 50 Hz for 1 minute between auxiliary / input / output

For Wiring Solution see page 30

Integra DL 1 dual load metering system

FEATURES

- One meter for split load panels
- * Meter with RJ12 CT connection for easy installation
- Two display mode operation
- Modbus RTU RS485 as standard
- User-programmable CT ratio and system configuration
- True rms measurement
- Continuous busbar or individual busbar metering
- Can be programmed for one individual power load

APPROVALS

- IEC 61326
- IEC 61010-1
- IEC 62053-21
- RoHS Compliant

BENEFITS

- Cost-effective, single meter solution
- UK manufactured
- CL0.5 accuracy
- Modbus communications
- Fully configurable
- Additional facility to accumulate the total system power/kWhs - displaying the combined system total parameters

Designed, developed and manufactured in the UK, the Integra DL1 is a digital metering system which provides measurement, isolation and conversion of all main electrical parameters from 2x three-phase loads, in a single meter. It can be used in single and three-phase unbalanced four-wire electrical systems and as an accuracy of CL0.5.

The Integra DL1 has an integrated microprocessor for exceptional waveform handling of distorted waveforms, and is ideal for low voltage applications. It provides a cost effective way of metering split load distribution and panel boards, in a single metering solution.

PRODUCT CODES

Description	Part number
Integra DL1 multifunction DIN-rail LCD Input 400 V L-L, 100 mA AC x 2 Modbus RTU RS 485 Self powered	DL1-01



TWO LOADS

Power or Lighting import kWh



Amps per phase



Individual import kWh readings



System import kWh



Display test



FEATURES

- Power and Lighting indicators can be changed to Load 1 and Load 2
- Each Load can be programmed for CT primary of 60A, 125 A or 250 A
- Additional facility to accumulate the total system power/kWhs - displaying the combined Power and Lighting system total parameters



Integra DL 1 dual load metering system

DIMENSIONS

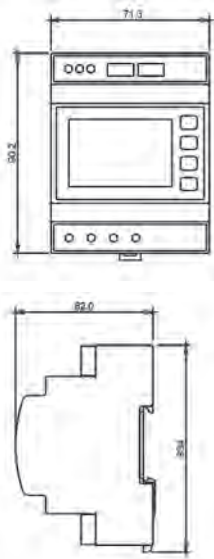

WIRING DIAGRAMS

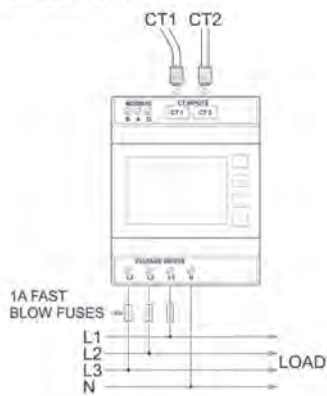

3-phase, 4-wire

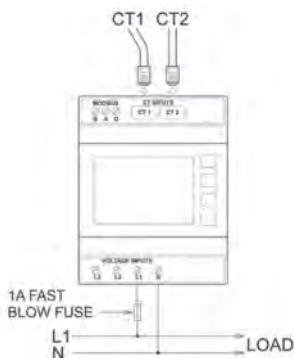

Single-phase, 2-wire

DISPLAYED PARAMETERS

Power (Load 1)	Lighting (Load 2)	System
Current L1	Current L1	Current L1
Current L2	Current L2	Current L2
Current L3	Current L3	Current L3
kW L1	kW L1	Voltage L1
kW L2	kW L2	Voltage L2
kW L3	kW L3	Voltage L3
Average System Volts	Average System Volts	Average System Volts
Average System Current	Average System Current	Average System Current
Average System kW	Average System kW	Average System kWh
kWh Import	kWh Import	kWh Import - Power
		kWh Import - Lighting
		kWh Import - Total
		Frequency
		Power Factor (PF)

SPECIFICATION

Input	
Nominal input voltage	100 V to 230 V AC rms., L – N. 173 V to 400 V AC rms., L – L
Max. continuous input overload voltage	120% of nominal
Max. short duration input voltage (1 sec)	2 x nominal voltage
Nominal input voltage burden	0.2 VA per phase (Except L1)**Self powered using the meter electrical input from L1 (6 VA)
Nominal input current	100 mA AC rms. per CT
System CT primary values	1-9999 A (selectable from display)
CT burden	0.1 VA
Accuracy	
Voltage (V)	< 0.5%
Current (A)	< 0.5%
Frequency (Hz)	< 0.2% of mid range
Power factor (PF)	1% of unity
Active power (W)	+/- 1.0% Class 1 IEC 62053-21
Active energy (kWh)	+/- 1.0% Class 1 IEC 62053-21
Range	
Voltage (V)	5% to 120% for nominal
Current (A)	5% to 120% of nominal
Frequency	45 – 65 Hz
Power	1 – 144% of nominal 0.8 capacitive – 1 – 0.8
Power factor	Inductive (functional 4 quadrant, 0-1 lag lead)
Energy	6-digit resolution and to be displayed in kWh (Maximum display 999999, before rollover to 0)
Outputs	
Communication protocol	RS485 Modbus RTU
Type	2-wire half duplex
Baud rate	9600, 19200, 38400
Enclosure	
Enclosure style	DIN-rail mounting EN43880
Dimensions	72 x 90 x 62 mm
Material	Polycarbonate to UL94-V0
Weight	0.25 kg
Terminals voltage	Shrouded screw-clamp 0.05-4 mm wire
Terminals CT	RJ12 connector
Sealing	IP52 front of panel
Environment	
Operating temperature	-10°C to +55°C
Storage temperature	-20°C to +70°C
Relative humidity	0-90% non-condensing
Shock	30 g in 3 planes and vibration of 0 Hz to 50 Hz IEC 60068-2-6, 2 g
Vibration	0 Hz to 50 Hz, IEC 60068-2-6, 2 g. Withstand test 2.2 kV, 50 Hz for 1 minute between auxiliary / input / output

Integra DL 1 dual load wiring solution

FEATURES

- Busbar DIN-rail and metal feet (mounting hardware supplied)
- RJ12 socket for fast connection eliminate wiring errors
- Cable included (length 1.5 m)
- Low 60 A ratio for more energy efficient loads
- Aperture hole centres 35 mm



DUAL LOAD CT PHASE ORIENTATION

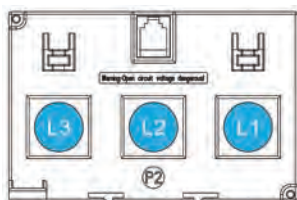

BENEFITS

- Easy installation
- Reduced assembly time
- Eliminates connection errors

The 3-in-1 current transformer range are for use with the Integra DL1 digital metering system which combines three traditional current transformers in one moulding case with a RJ12 connection for simple and easy error free installation.

All current transformers are supplied with a 1.5m connecting cable, with RJ12 connector termination at each end.

SPECIFICATIONS

System voltage	720 V maximum
Test voltage	3 kV for 1 minute
System frequency	50 Hz or 60 Hz
Primary ratings	100 mA AC rms. per CT
Overload withstand	1.2 x rated current continuously
Enclosure	Flame retardant grade classified UL94V-0
Aperture hole centres	35 mm
Operating temperature	-20°C to +85°C
Compliant with accuracy	IEC/EN 60044-1 Class 0.5, Class 1

CURRENT TRANSFORMERS PRODUCT CODES

Product Codes	Primary Current	VA at Class 1	VA at Class 0.5
DL3N1-35-60/0.1	60 A	0.25	-
DL3N1-35-125/0.1	125 A	0.5	0.25
DL3N1-35-160/0.1	160 A	0.35	0.25
DL3N1-35-250/0.1	250 A	0.5	0.25
DL3N1-45-250/0.1	250 A	0.25	-
DL3N1-45-400/0.1	400 A	-	0.25
DL3N1-45-600/0.1	600 A	-	0.25
DL3N1-70-400/0.1	400 A	-	0.25
DL3N1-70-600/0.1	600 A	-	0.25
DL3N1-70-800/0.1	800 A	-	0.25

DIMENSIONS

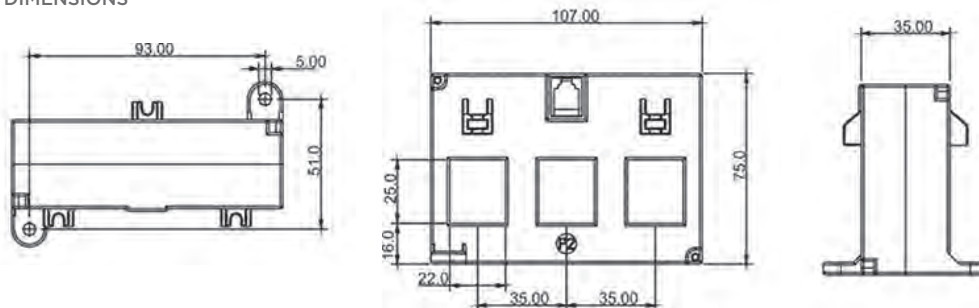

Integra TL1 tri load metering system

FEATURES

- Single meter for 3x three-phase loads
- Multiple display modes
- Modbus RTU RS485 as standard
- User-programmable CT ratio and system configuration
- True rms measurement
- Continuous busbar or individual busbar metering
- Can be programmed for individual power loads when required
- RJ12 socket for fast connection
- Optional DIN 96 mm panel mounting bezel can be supplied

APPROVALS

- IEC 61326
- IEC 61010-1
- IEC 62053-21
- RoHS Compliant

BENEFITS

- Cost-effective, single meter solution
- UK manufactured
- CL1.0 accuracy for Energy
- Modbus communications
- Fully configurable
- Additional facility to accumulate the total system power/kWhs -displaying the combined system total parameters

Designed, developed and manufactured in the UK, the Integra TL1 is a digital metering system which provides measurement, isolation and conversion of all main electrical parameters from 3x three-phase loads, in a single meter. It can be used in three-phase unbalanced four-wire electrical systems and has an accuracy of CL1 Energy.

PRODUCT CODES

Description	Part number
Integra TL1 DMS	TL1-01

DISPLAYED PARAMETERS

Load 1	Load 2	Load 3	System
Current L1	Current L1	Current L1	Current L1
Current L2	Current L2	Current L2	Current L2
Current L3	Current L3	Current L3	Current L3
kW L1	kW L1	kW L1	Voltage L1
kW L2	kW L2	kW L2	Voltage L2
kW L3	kW L3	kW L3	Voltage L3
Average System Volts	Average System Volts	Average System Volts	Average System Volts
Average System Current	Average System Current	Average System Current	Average System Current
Average System kW	Average System kW	Average System kW	Total System kWh
kWh Import	kWh Import	kWh Import	kWh Import - Load 1
			kWh Import - Load 2
			kWh Import - Load 3
			Frequency
			Power Factor (PF)



DIMENSIONS

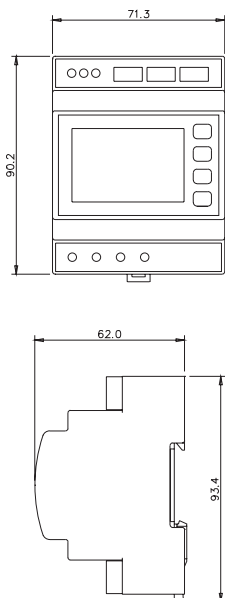

Integra TL1 tri load metering system

WIRING DIAGRAM

3 Phase, 4 wire

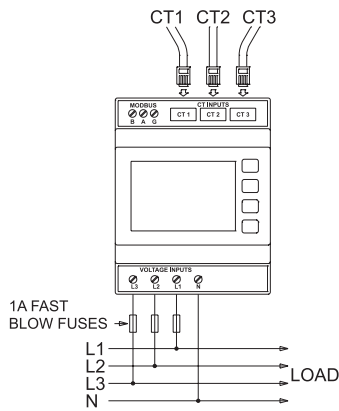

SPECIFICATIONS

Input	
Nominal input voltage	100 V to 230 V AC rms., L – N. 173 V to 400 V AC rms., L – L
Max. continuous input overload voltage	120% of nominal
Max. short duration input voltage (1 sec)	2 x nominal voltage
Nominal input voltage burden	0.2 VA per phase (Except L1)**Self powered using the meter electrical input from L1 (6 VA)
Nominal input current	100 mA AC rms. per CT
System CT primary values	1-9999 A (selectable from display)
CT burden	0.1 VA
Accuracy	
Voltage (V)	< 0.5%
Current (A)	< 0.5%
Frequency (Hz)	< 0.2% of mid range
Power factor (PF)	1% of unity
Active power (W)	+/- 1.0%
Active energy (kWh)	+/- 1.0% Class 1 IEC 62053-21
Range	
Voltage (V)	5% to 120% for nominal
Current (A)	5% to 120% of nominal
Frequency	45 – 65 Hz
Power	1 – 144% of nominal 0.8 capacitive – 1 – 0.8
Energy	6-digit resolution and to be displayed in kWh (Maximum display 999999, before rollover to 0)
Outputs	
Communication protocol	RS485 Modbus RTU
Type	2-wire half duplex
Baud rate	9600, 19200, 38400
Enclosure	
Enclosure style	DIN-rail mounting EN43880
Dimensions	72 x 90 x 62 mm
Material	Polycarbonate to UL94-V0
Weight	0.25 kg
Terminals voltage	Shrouded screw-clamp 0.05 – 4 mm wire
Terminals CT	RJ12 connector
Sealing	IP52 front of panel
Environment	
Operating temperature	-10°C to +55°C
Storage temperature	-20°C to +70°C
Relative humidity	0 – 90% non-condensing
Shock	30 g in 3 planes and vibration of 0 Hz to 50 Hz IEC 60068-2-6, 2 g
Vibration	0 Hz to 50 Hz, IEC 60068-2-6, 2 g. Withstand test 2.2 kV, 50 Hz for 1 minute between auxiliary / input / output

	Operating Mode	
	Tri1	Tri2
Load 1 (CT1)	CT1 - CT2	CT2 - CT3
Load 2 (CT2)	CT2 - CT3	CT1 - CT2
Load 3 (CT3)	CT3	CT3

	Operating Mode
	Tri3
Load 1 (CT1)	CT1
Load 2 (CT2)	CT2
Load 3 (CT3)	CT3

Integra TL1 tri load wiring solution

FEATURES

- Busbar DIN-rail and metal feet (mounting hardware supplied)
- RJ12 socket for fast connection eliminate wiring errors
- Cable included (length 1.5 m)
- Low 60A ratio for more energy efficient loads
- Aperture hole centres 35 mm



ALL CURRENT TRANSFORMERS ARE SUPPLIED WITH A 1.5M CONNECTING CABLE, WITH RJ12 CONNECTOR TERMINATION AT EACH END.

DUAL LOAD CT PHASE ORIENTATION

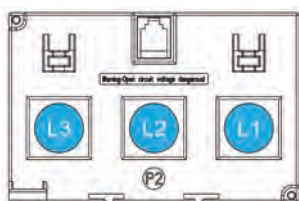

BENEFITS

- Easy installation
- Reduced assembly time
- Eliminates connection errors

The 3-in-1 current transformer range are for use with the Integra DL1 digital metering system which combines three traditional current transformers in one moulding case with a RJ12 connection for simple and easy error free installation.

SPECIFICATIONS

System voltage	720 V maximum
Test voltage	3 kV for 1 minute
System frequency	50 Hz or 60 Hz
Primary ratings	100 mA AC rms. per CT
Overload withstand	1.2 x rated current continuously
Enclosure	Flame retardant grade classified UL94V-0
Aperture hole centres	35 mm
Operating temperature	-20°C to +85°C
Compliant with accuracy	IEC/EN 60044-1 Class 0.5, Class 1

CURRENT TRANSFORMERS PRODUCT CODES

Product Codes	Primary Current	VA at Class 1	VA at Class 0.5
DL3N1-35-60/0.1	60 A	0.25	-
DL3N1-35-125/0.1	125 A	0.5	0.25
DL3N1-35-160/0.1	160 A	0.35	0.25
DL3N1-35-250/0.1	250 A	0.5	0.25
DL3N1-45-250/0.1	250 A	0.25	-
DL3N1-45-400/0.1	400 A	-	0.25
DL3N1-45-600/0.1	600 A	-	0.25
DL3N1-70-400/0.1	400 A	-	0.25
DL3N1-70-600/0.1	600 A	-	0.25
DL3N1-70-800/0.1	800 A	-	0.25

DIMENSIONS

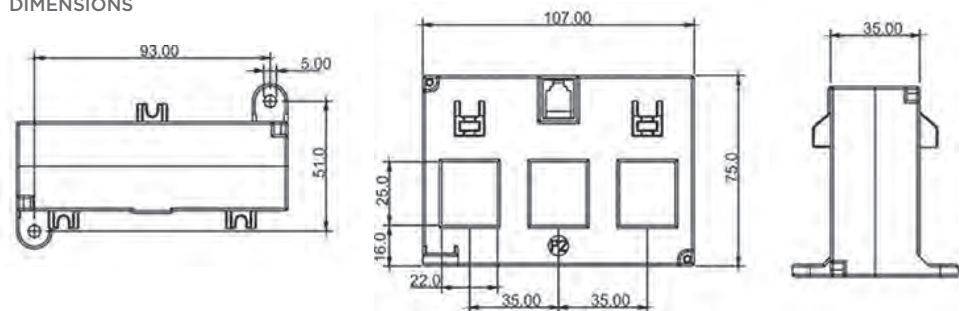





Chapter 4 Integra 1630 and 1530 digital metering systems – panel mounted

Integra 1630 digital metering system.....	36
Integra 1530 digital metering system.....	39

Integra 1630 digital metering system

FEATURES

- Low profile
- High contrast LED display
- LED annunciators for each measured parameter
- User programmable system configuration (4-wire default)
- Fully programmable VT and CT ratios
- Current demand per phase
- Elapsed time counter for connected loads
- Removable bezel for very low profile applications



PROGRAMMABLE PARAMETERS

Parameter	Range
Password	4-digit 0000-9999
CT primary current	Maximum 9999A ** CT Secondary Current: 5 A (1 A option)
VT primary voltage	Maximum 400 kV **
VT secondary voltage	Nominal input voltage ** maximum VT or CT ratios are limited so that the combination of primary voltage and current do not exceed 360 MW at 120% of relevant input
Demand integration time	8, 15, 20, 30, 60 minutes
3 independent resets	Demands and maximum demands Energy registers Hours run
Pulse output duration	60, 100, 200 milliseconds
Pulse rate divisors	1, 10, 100, 1000
RS485 baud rate	4.8, 9.6, 19.2, 38.4 kBd
RS485 parity and stop bits	Odd or even with 1 stop bit or no parity with 1 or 2 stop bits

APPROVALS

- IEC1010-1 (BSEN 61010-1 – 2001)

The Integra 1630 digital metering system (dms) provides high accuracy 0.2% measurement, display and communication of all major electrical and power quality parameters including total harmonic distortion (THD) up to the 31st harmonic. To suit user requirements, the range includes single-phase, three-phase three-wire and three-phase four-wire capability, all selectable at the point of installation.

This DIN 96 panel mounting enclosure offers simple programming and display of up to 35 electrical parameters via a simple menu-driven user interface on the front panel. Optional pulsed and digital communication outputs are available, to allow up to 60 parameters to be communicated to building management systems. A Windows-based software package is available to remotely configure the Integra dms and display all 60 major parameters.

OPERATION

Integra 1630 dms offers uncomplicated operation and high accuracy measurement of three-phase voltage, current, frequency, Watts, VAR, VA, energy, power factor, and total harmonic distortion of both phase and system, current and voltage. Integra 1630 dms includes true measurement of both line-to-neutral, and line-to-line voltages, ensuring accurate readings. The pre-calibrated plug-in option cards allow cost effective upgrades with any combination of pulsed, analogue and digital communication outputs. Cards slot simply into the back of the unit and products do not need to be removed from the installation or recalibrated.

COMMUNICATION

Integra 1630 dms offers a wide range of communication protocols including:

- Pulsed outputs
- Modbus RTU RS 485 Protocol
- Modbus TCP (Ethernet)
- BACnet IP Interface
- BACnet MSTP Interface
- Profibus DP Protocol

PRODUCT CODES

Description	Cat. no.
1-phase, 3-phase 3/4-wire, 100 - 240 V L-L, 5 A CT input, Aux. 100 - 250 V AC/DC	INT-1630-L-5-M-option
1-phase, 3-phase 3/4-wire, 241 - 480 V L-L, 5 A CT input, Aux. 100 - 250 V AC/DC	INT-1630-M-5-M-option
Options	
No options	000
1 pulsed output	100
2 pulsed output	200
Modbus RTU RS485 protocol	010
Modbus RTU RS485 protocol + 1 kWhr pulsed output	110
Modbus RTU RS485 protocol + 2 kWhr pulsed output	210
Profibus™	050
Modbus RTU RS485 protocol TCP	070
BACnet IP interface	080
BACnet MSTP interface	090
Extended collar	OPT-1630-collar

BENEFITS

- True rms measurement
- High accuracy <0.2% on some measurements
- Configurable via software package or menu-driven interface
- Import and export monitoring

Integra 1630 digital metering system

PANEL CUT-OUT

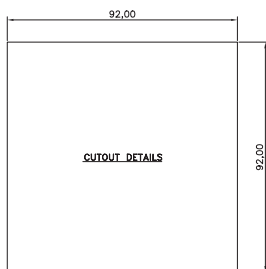

SPECIFICATIONS

Input	
Nominal input voltage	57.7 to 277 V L-N, 100 to 480 V L-L
Max. continuous input voltage	120% of nominal
Max. short duration input voltage	2 x nominal for 1 second, repeated 10 times at 10 second intervals
System VT ratios (primary)	Any significant 4-digit integer value up to 400 kV **
Nominal input voltage burden	<0.2 VA
Nominal input current	5 A (1 option)
System CT primary values	Any integer value up to 9999 A **
Max. continuous input current	120% nominal
Max. short duration input current	20 x nominal for 1 second, repeated 5 times at 5 minute intervals
Nominal input current burden	< 0.6 VA ** maximum CT and VT ratios are limited so that the combination of primary voltage and current do not exceed 360 MW at 120% of relevant input
Output modules (optional)	
RS485 communications	2-wire half duplex
Baud rates	4800, 9600, 19200, 38400
Pulsed	Solid state relays
Pulse duration	60, 100 or 200 milliseconds
Contact rating	50 mA max at 250 V AC max
Pulsed outputs	1 or 2
Auxiliary	
Standard nominal supply	100-250 V AC or DC voltage: (85-287 V AC absolute limits) (85-312 V DC absolute limits)
AC supply frequency range	45 – 66 Hz
AC supply burden	6 VA
Optional auxiliary DC supply	12 – 48 V DC (10.2-60 V DC absolute limits)
DC supply burden	6 VA
Measuring Ranges	
Voltage	80 – 120% of nominal (functional 5-120%)
Current	5 – 120% of nominal
Frequency	45 – 66 Hz
Measuring Ranges	
Power factor	0.8 capacitive–1–0.8 inductive (functional 4 quadrant, 0-1 lag/lead)
THD	Up to 31st harmonic 0 – 40% Measured voltage >5% of range Measured current >5% of nominal Full accuracy of voltage >25% of range Full accuracy of current >25% of nominal
Energy	7-digit resolution
Reference conditions	
Ambient temperature	23 ±1°C
Input frequency	50 or 60 Hz ±2%
Input waveform	Sinusoidal (distortion factor < 0.005)
Auxiliary supply voltage	Nominal ±1%
Auxiliary supply frequency	Nominal ±1%
AC auxiliary supply waveform	Sinusoidal (distortion factor < 0.05)
Magnetic field of external origin	Terrestrial flux
Accuracy	
Voltage	±0.17% of range maximum
Current	±0.17% of nominal
Frequency	±0.15% of mid frequency
Active power	±0.2% of range maximum
Power factor	1% of unity
Reactive power (VAR)	±0.5% of range maximum
Apparent power (VA)	±0.2% of range maximum
THD	±1%
Neutral current calculated	±0.95% of nominal
Energy	0.3% of range maximum (Better than class 1) IEC1036 Sect 4.6)
kVArh	0.6% of range maximum
Temperature coefficient	Voltage and current typical: 0.013%/°C Watts typical: 0.018%/°C

Integra 1630 digital metering system

SPECIFICATIONS

Enclosure	
Enclosure style	Enclosure style
Compliant with	IEC 1010-1/ BSEN 61010-1 : 2001 CAT III, CE EMC and LVD directives
Material	Polycarbonate
Terminals	Shrouded screw-clamp 0.05 mm to 4 mm wire
Dielectric voltage	Withstand test 3.25 kV rms 50 Hz for 1 minute between all electrical circuits
Operating temperature	-20 to +60°C
Storage temperature	-30 to +80°C
Relative humidity	0 – 90% (non condensing)
Warm-up time	1 minute
Shock	30 g in 3 planes
Vibration	10-18 Hz, 1.5mm peak-to-peak 18-150 Hz @1 g
IP protection	IP54
Dimensions	96 mm wide x 96 mm high x 79 mm deep (max). Typically <60 mm depth behind panel
Panel cut-out	92 mm x 92 mm, 3.62" x 3.62"

DIMENSIONS

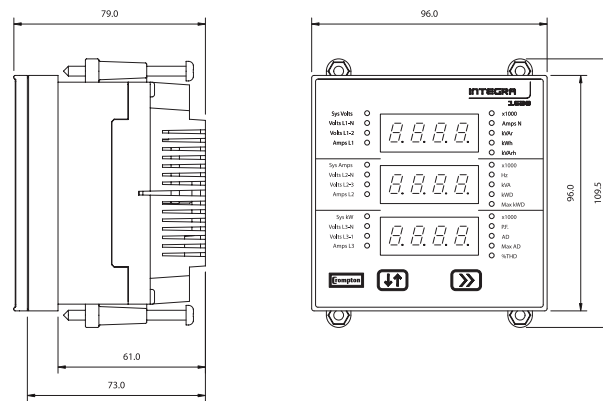

WIRING

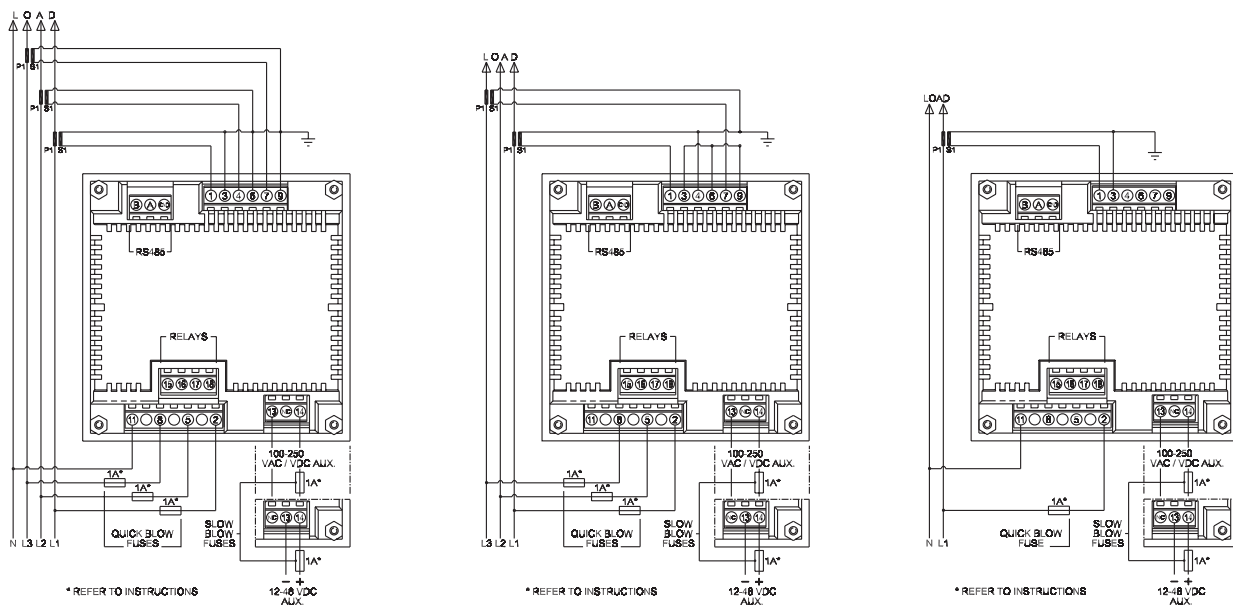

Integra 1530 digital metering system

FEATURES

- Measure and display up to 34 electrical and power parameters
- High-contrast red LED display
- THD measurement and power quality data to 31st harmonic
- True rms measurement
- Pulsed, analogue and digital outputs
- Modbus, Johnson Controls and Lonworks protocol interface options
- Fully programmable VT and CT ratios



APPROVALS

- UL file no: E20300
- UL 61010B-1
- IEC 1010-1/BSEN 61010-1 CAT III

BENEFITS

- Replaces multiple single function instruments
- Pre-calibrated plug-in options
- High accuracy <0.2%
- Configurable via software package or menu driven interface
- Import and export monitoring
- Neutral CT input option
- True 3-and 4-wire measurement

The Integra 1530 series instruments provide high accuracy <0.2% measurement, display and communication of all major electrical and power quality parameters, including true rms system values, and total harmonic distortion (THD) up to the 31st harmonic.

This DIN 96 panel mounting offers programming and display of up to 34 power measurement parameters. Optional pulsed, analogue and digital communication outputs, allow the communication of information of up to 50 measured parameters into building management systems. A Windows-based software package is available to remotely configure the Integra dms and display all 60 major parameters.

OPERATION

Integra 1530 digital metering system (dms) offers uncomplicated operation and high accuracy measurement of three-phase voltage, current, frequency, Watts, VAr, VA, energy, power factor, and total harmonic distortion of both phase and system, current and voltage. Integra 1530 dms includes true measurement of both line-to-neutral, and line-to-line voltages, ensuring accurate readings.

PROGRAMMABLE DISPLAY

A two-button interface on the front panel provides configuration programming of system (three-phase four-wire etc), VT and CT ratio settings, selected communication options and adjustment of operating parameters. All set-up screens offer password protection.

PROGRAMMABLE PARAMETERS

Parameter	Range
Password	4-digit 0000-9999
Primary current	Max 9999:5 A (360 MW max**)
VT primary	400 kV (360 MW max**)
Secondary voltage	Nominal system voltage ** maximum VT and CT ratios are limited so that the combination of primary voltage and current does not exceed 360 MW at 120% of relevant input
Demand integration time	8, 15, 20, 30 and 60 minutes
Reset	Max demand and active energy registers
Pulse output duration	60, 100, 200 ms
Pulse rate divisors	1, 10, 100, 1000
RS485 interface baud rate	2.4, 4.8, 9.6, 19.2kB
RS485 parity	Odd/even/no, 1 or 2 stop bits
Modbus RTU RS485 protocol address	1-247
Analogue outputs	User definable

SYSTEM INPUTS

Designed for all low, medium and high voltage switchgear and distribution systems, the Integra 1530 meter offers programmable VT and CT ratio capability. Direct connection for up to 480 V AC with 5 A CT inputs is standard, and 1 A CT inputs available as an option.

NEUTRAL CT INPUT OPTION

Integra 1530 dms offers a three-phase four-wire version with a neutral 4th CT, allowing true neutral current measurement and protection in high harmonic environments.

COMMUNICATION

Integra 1630 dms offers a wide range of communication protocols including:

- Pulsed outputs
- Modbus RTU RS 485 Protocol
- Lonworks Protocol

PRODUCT CODES

Description	Cat. no.
1-phase 2-wire 100 – 240 V L-L, 5 A CT input. Aux. 100-250 V AC/DC	INT-1630-L-5-M-option
1-phase 2-wire 241 – 480 V L-L, 5 A CT input. Aux. 100-250 V AC/DC	INT-1531-M-5-M-option
1-phase 3-wire 100 – 240 V L-L, 5 A CT input. Aux. 100-250 V AC/DC	INT-1532-L-5-M-option
1-phase 3-wire 241 – 480 V L-L, 5 A CT input. Aux. 100-250 V AC/DC	INT-1532-M-5-M-option
3-phase 3-wire 100 – 240 V L-L, 5 A CT input. Aux. 100-250 V AC/DC	INT-1533-L-5-M-option
3-phase 3-wire 241 – 480 V L-L, 5 A CT input. Aux. 100-250 V AC/DC	INT-1533-M-5-M-option
3-phase 4-wire 100 – 240 V L-L, 5 A CT input. Aux. 100-250 V AC/DC	INT-1534-L-5-M-option
3-phase 4-wire 241 – 480 V L-L, 5 A CT input. Aux. 100-250 V AC/DC	INT-1534-M-5-M-option
3-phase 4-wire with true neutral measurement 100-240 V L-L, 5 A CT input, Aux 100 – 250 V AC/DC	INT-1535-L-5-M-option
3-phase 4-wire with true neutral measurement 241 – 480 V L-L, 5 A CT input, Aux 100 – 250 V AC/DC	INT-1535-M-5-M-option
Options	
Lonworks protocol	030
1 analogue output (0/20 mA)	001=1
2 analogue outputs (0/20 mA)	002=1

Integra 1530 digital metering system

DIMENSIONS

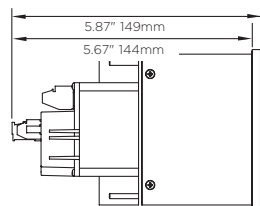
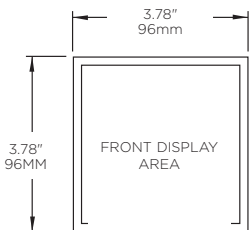

PANEL CUT-OUT

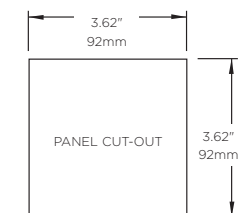

MAX PANEL THICKNESS 0.19", 5mm

SPECIFICATIONS

Input	
Nominal input voltage	57.7 to 277 V L-N, 100 to 480 V L-L
Max. continuous input voltage	120% of nominal
Max. short duration input voltage	2 x for 1 second, repeated 10 times at 10 second intervals
System VT ratios (primary)	Any value up to 400 kV **
Nominal input voltage burden	<0.2 VA
Nominal input current	5 A (1 option)
System CT primary values	9999:5 A or 9999:1 A max 360 MW **
Max. continuous input current	120% nominal
Max. short duration input current	20 x for 1 second, repeated 5 times at 5 second intervals
Optional auxiliary DC supply	12 – 48 V DC (10.2 – 60 V DC absolute limits)
Nominal input current burden	< 0.6 VA ** maximum VT and CT ratios are limited so the combination of primary voltage and current does not exceed 360 MW at 120% of relevant input
Output (optional)	
RS485 communications	2-wire half duplex
Baud rates	2400, 4800, 9600, 19200
Pulsed	Clean contact SPNO
Pulse duration	60, 100 or 200 milliseconds
Pulsed outputs	1 or 2
Analogue outputs	1 or 2
Auxiliary	
Standard nominal supply voltage	100 – 250 V, AC or DC 85 – 287 V, AC absolute) (85 – 312 V, DC absolute)
AC supply frequency range	45 – 66 Hz
AC supply burden	6 VA
Optional auxiliary DC supply	12 – 48 V DC (10.2 – 60 V DC absolute)
DC supply burden	6 VA
Measuring Ranges	
Voltage	80 – 120% of nominal (functional 5 – 120%)
Current	5 – 120% of nominal
Frequency	45 – 66 Hz
Power factor	0.8 capacitive–1–0.8 inductive (functional 4 quadrant, 0-1 lag/lead)
THD	Up to 31st harmonic (0% – 40%)
Energy	7-digit resolution
Reference conditions	
Ambient temperature	23 ±1°C
Input frequency	50 or 60 Hz ±2%
Input waveform	Sinusoidal (distortion factor < 0.005)
Auxiliary supply voltage	Nominal ±1%
Auxiliary supply frequency	Nominal ±1%
AC auxiliary supply waveform	Sinusoidal (distortion factor < 0.05)
Magnetic field of external origin	Terrestrial flux
Accuracy	
Voltage	±0.17% of range maximum
Current	±0.17% of nominal
Frequency	±0.15% of mid frequency
Active power	±0.2% of range maximum
Power factor	1% of unity
Reactive power (VAr)	±0.5% of range maximum
Apparent power (VA)	±0.2% of range maximum
THD	±1%
Neutral current calculated	±0.95% of nominal
Energy	0.3% of range maximum (Better than class 1) IEC1036 Sect 4.6)
kVArh	0.6% of range maximum
Temperature coefficient	Voltage and current typical: 0.013%/°C Watts typical: 0.018%/°C

Integra 1530 digital metering system

MEASUREMENT AND DISPLAY

Up to 34 electrical and power quality parameters can be configured and displayed on the Integra 1530 dms unit.

- 1 System volts
System current
System kW
- 2 System volts THD %
System current THD %
- 3 Volts L1 - N (4-wire only)
Volts L2 - N (4-wire only)
Volts L3 - N (4-wire only)
- 4 Volts L1 - L2
Volts L2 - L3
Volts L3 - L1
- 5 Volts line 1 THD %
Volts line 2 THD %
Volts line 3 THD %
- 6 Current L1
Current L2
Current L3
- 7 Current line 1 THD %
Current line 2 THD %
Current line 3 THD %
- 8 Neutral current (4-wire only)
Frequency
Power factor
kVAr
kVA
kW
- 10 kWh import (7-digit resolution)
- 11 kWh export (7-digit resolution)
- 12 kWh import (7-digit resolution)
- 13 kWh export (7-digit resolution)
- 14 kW demand
Current demand
- 15 kW maximum demand
Current maximum demand

Enhanced status information of up to 50 parameters can be communicated into building management systems via optional pulsed, analogue and digital outputs.

SPECIFICATIONS

Enclosure	
Enclosure style	DIN 96 panel mount
Compliant with	UL E20300, UL61010B-1, IEC 1010-1/BSEN 61010-1 CATIII, EMC and LVD
Material	Polycarbonate
Terminals	Shrouded screw-clamp
Dielectric voltage	Withstand test 3.25 kV rms 50 Hz for 1 minute between all electrical circuits
Operating temperature	-20 to +60°C
Storage temperature	-30 to +80°C
Relative humidity	0 - 90% (non condensing)
Warm-up time	1 minute
Shock	30 g in 3 planes
Vibration	10-15 Hz, 1.5 mm peak-to-peak/15-150 Hz @ 1 g IP protection: IP54
Dimensions	96 mm wide x 96 mm high x 149 mm deep (max) 3.78" wide x 3.78" high x 5.87" deep (max)
Panel cut-out	92 mm x 92 mm, 3.62" x 3.62"

CONNECTIONS

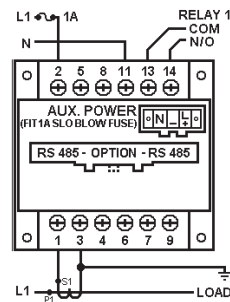

Single-phase

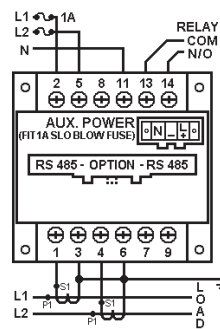

Single-phase 3-wire

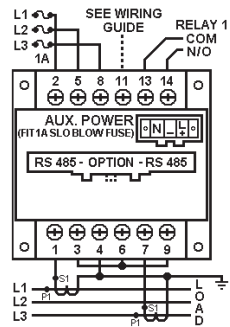

3-phase 3-wire

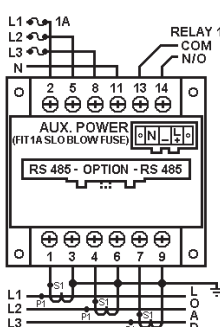

3-phase 4-wire

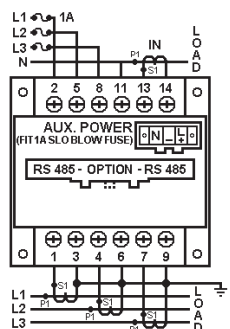

3-phase 4-wire with neutral CT

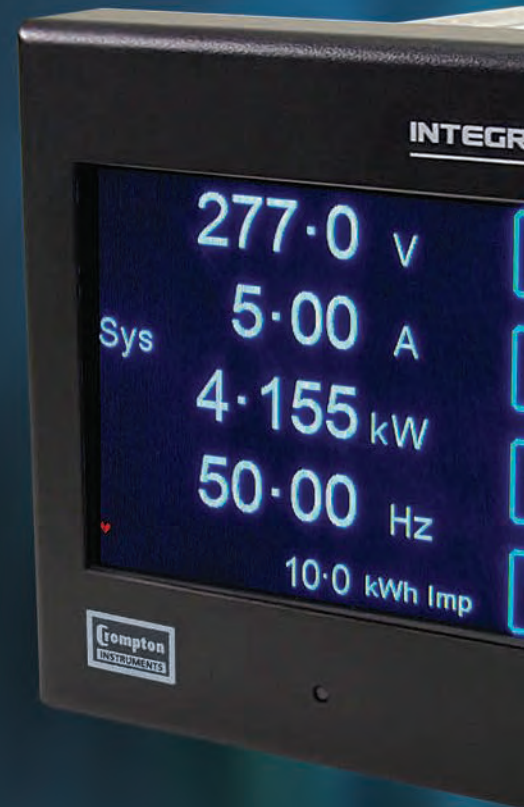
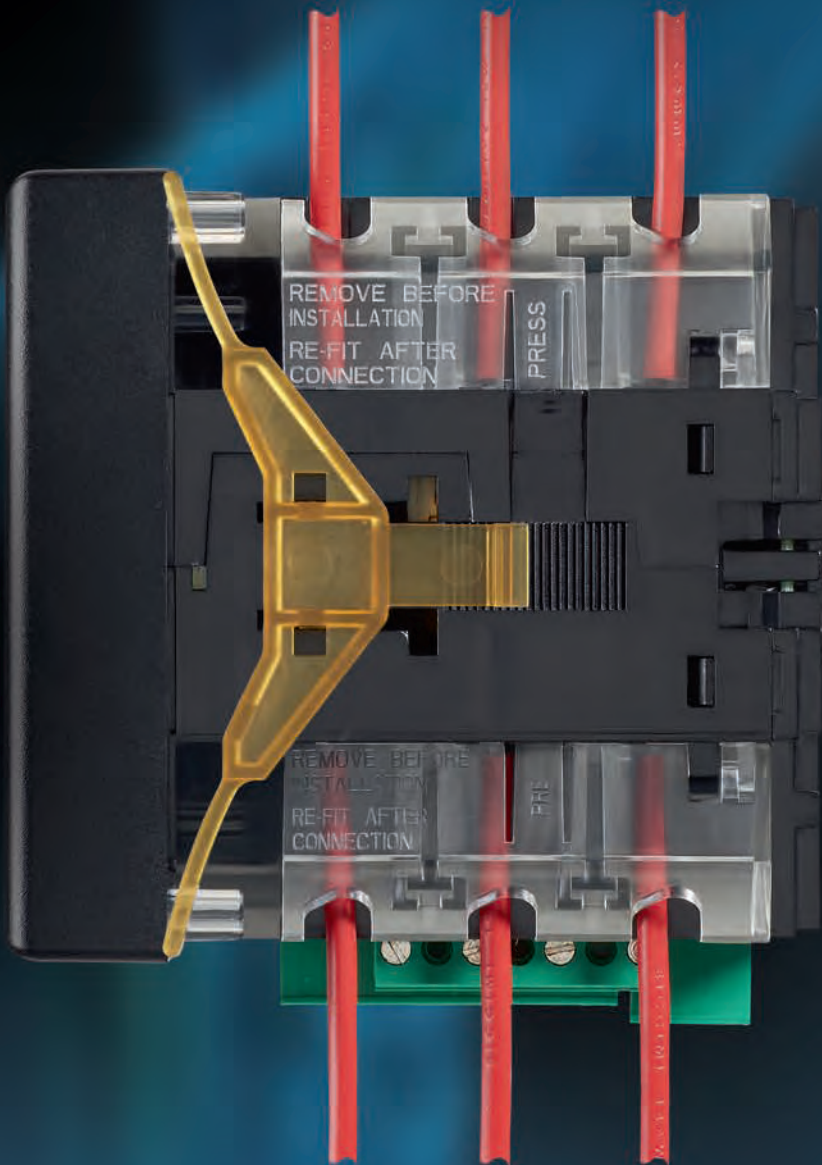



Chapter 5 Integra 2170 and 2270 power quality metering system

Integra 2170 power quality meter.....	44
Integra 2270 power quality meter.....	46

Integra 2270 power quality meter

Power to analyse quality, with a touch

FEATURES (INT 2170 AND 2270)

- Full colour, energy efficient, touch screen user interface
- Alarm/pulsed output
- Pulsed inputs
- Min/Max value stored in non-volatile memory
- Individual harmonics measurement to 63rd harmonic
- Percentage of load bar for full scale indication
- Accuracy to 0.5S% (reading)
- Sub cycle transient monitoring



FEATURES (INT-2270 ONLY)

- Waveform capture 8 cycles per phase
- Sags/swells monitoring to BS EN 50160
- Accuracy to 0.2S% (reading)

BENEFITS

- Fits both ANSI and DIN cut-outs
- User programmable configuration
- Heart beat indication for self checking
- Soft alarms
- User programmable display screen
- Single meter for all utilities including water and gas
- Wiring solution

The Integra 2x70 power quality meter provides information about energy consumption and its quality by monitoring three basic measurements:

- Total Harmonic Distortion: the total distortion in the supply, caused by multiples of the base frequency up to the 63rd harmonic
- Waveform Capture: allowing instantaneous events to be captured and analysed offline using a computer
- Voltage Interference: also known as 'sags and swells'. This measures variations in the voltage supply caused by non-linear loads, classified to BS EN 50160:2010.

The Integra 2270 digital meter provides measurement, isolation and conversion of all main electrical parameters and can be used in single-phase and three-phase three-wire unbalanced, four-wire balanced and unbalanced systems. RS485 Modbus RTU communications protocol, pulse/alarm outputs and inputs are fitted as standard.

SIGNAL CONDITIONING

- Patented* technology enables measurement of power quality within any voltage of electrical supply, in a single product, covering the global range 100/600V of electrical supplies.

FULL COLOUR TOUCH SCREEN DISPLAY

- Energy-efficient and intuitive touch screen display with clear graphics and simple navigation which is easy to set up and configure.

INPUTS AND OUTPUT

- Total measurement for all utilities in a single meter, including measurement of pulses from water and gas meters.
- Can be configured to communicate outputs relating to active and reactive energy to building management systems
- Alarms can be configured for any relevant, measured parameters and can also serve as a trip function.

EASY INSTALLATION

- Plug and socket connectivity for easy installation of prewired looms and reduction of wiring errors. Current flows directly through the meter primary CTs, meaning there is no need to terminate the CT wire at the meter.

PRODUCT CODES

Description	Part number
Integra 2270	INT-2270-M-01
Integra 2170	INT-2170-M-01

APPROVALS

EMC	IEC 61000-4-2 IEC 61000-4-3 IEC 61000-4-4 IEC 61000-4-5 IEC 61000-4-6 IEC 61000-4-8 IEC 61000-4-11 IEC 61326-1, Class A IEC 61000-3-2 IEC 61000-3-3
Safety	IEC 61010-1
Accuracy and Measurement	IEC 62053-21 class IEC 62053-22 class 0.2S IEC 62053-23 class 0.5S ANSI C12.20
Features	IEC 50160 (sag/swells classes) EN60688 ANSI C37.90.1 (surge withstand) ANSI C62.41 (Burst) RoHS compliant

MEASURED PARAMETERS

- Active power (kW) by phase
- Reactive power (kVAr) per phase
- Apparent power (kVA) per phase
- Current demand (AD) per phase
- Unbalanced voltage (%)
- Unbalanced current (%)
- Internal temperature measurement
- Hours run
- Supported real time clock

Integra 2270 power quality meter

Ensure error free installation and reduces wiring time by 80%

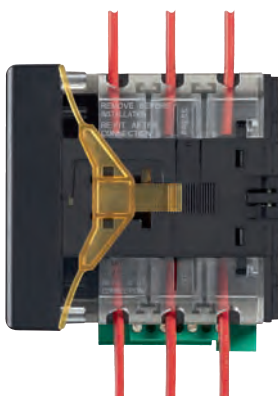

SPECIFICATIONS

Input	
Nominal input voltage	57.7 V – 346 V AC L-N (100 – 600 V L-L) 720 V MAX
Max. continuous input overload voltage	120% of nominal
Max. continuous input overload voltage	2 x nominal voltage for 1 second
Nominal input voltage burden	<0.5 VA per phase
Nominal input current	1 A AC or 5 A AC RMS
Nom. Input current burden	<0.1 VA
Max. continuous input overload current	120% of nominal
Max. continuous input overload current	20 x nominal current for 1 second
Auxiliary	
Operating range	110 – 250 V AC/DC (+/- 20%) 45 – 66 Hz (88-300 V AC absolute limit)
Supply burden	10 VA
Accuracy	
Voltage (V)	0.18% of reading + 0.02% nominal
Current (A)	0.18% of reading + 0.02% nominal
Neutral current calculated (A)	< 1.0%
Frequency (Hz)	< 0.1 Hz
Power factor (PF)	± 1% of unity
Active power (W)	± 0.25% of reading (at unity power factor)
Reactive power (VAr)	± 0.25% of reading (at unity power factor)
Apparent power (VA)	± 0.25% of reading (at unity power factor)
Active energy (kWh)	Class 0.2S (IEC 62053-22)
Reactive energy (kVArh)	Class 0.5S (IEC 62053-23)
THD	1%
Range	
Voltage (V)	20% to 120% of nominal
Current (A)	1% to 120% of nominal
Frequency	45 – 66 Hz
Power factor	1 .. 0 lead or lag, 4 quadrant
Active power	5 to 144% of nominal
Demand interval	8, 10, 15, 20, 30, 60
THD	up to 63rd harmonic
Energy	8 digit displayed in Wh, kWh, MWh (Maximum 9,999,999.9 MWh before rollover to 0.0)
Environment	
Operating temperature	-20°C to +60°C
Storage temperature	-30°C to +80°C
Relative humidity	0-95% non-condensing
Shock	30 g in 3 planes to IEC60068-2-6, 2 g
Vibration	10 Hz to 50 Hz, IEC 60068-2-6, 2 g
Dielectric voltage	Withstand test 2.5 kV, 50 Hz for 1 minute between auxiliary/input/output
IP protection (IEC 60529)	IP 52 front display IP 30 product
Altitude	Up to 2000 m
Installation category	CAT III
Protection class	II
Input waveform	Sinusoidal (distortion factor < 0.005)
Magnetic field of external origin	Terrestrial flux
Max wire gauge (input voltage, supply, I/O)	AWG 12/2.5 mm ²
Max wire gauge (current pass through)	0.177"/4.5 mm

Integra 2270 power quality meter

Power to analyse quality, with a touch

DIMENSIONS

- 100 x 70 x 118mm
- 3.94" x 3.11" x 4.65"
- Weight 0.42kg
- 92mm square DIN cut-out
- ANSI C39.1, 4" round

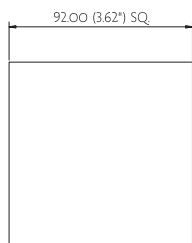

DIN CUTOUT

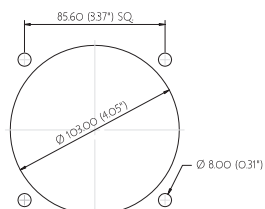

ANSI CUTOUT

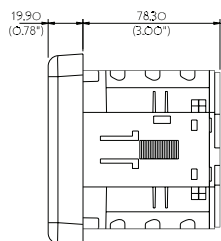
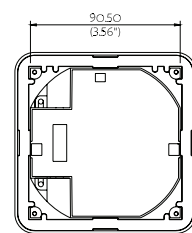
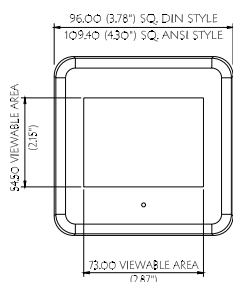

DISPLAY

Size	3.5" diagonal, 70 mm x 52.5 mm
Resolution	320 x 240 RGB
Colours	16 M
Type	Touch screen (TFT)
Outputs Pulsed	
Pulse/alarm output relay (KYZ)	User defined solid state relay
Contact rating	50 mA max at 250 V AC
Isolation	2.5 kV rms
Pulse duration	60, 100, 200 msec
Pulse rate divisor range	1 pulse per Wh up to 1 pulse per GWh
Pulsed output parameter	Import/export kWh/kVArh
Energy units	Kilo, mega, giga
Max pulse rate	2 pulses per second
Outputs (Alarm)	
Alarm trip and release	Any value in range
Alarm type	User defined solid state relay, latched and unlatched
Alarm delay	0 – 600 second
Delay resolution	10 ms
Modbus™ Protocol	
Communication protocol	RS485 Modbus RTU
Type	2-wire half duplex
Baud rate	2900, 4800, 9600, 19200, 38400
Inputs	
Number of digital (pulsed) inputs	2
Voltage rating	Logic high threshold > 2 volts Logic low threshold < 1.2 volts
Current rating	Logic high threshold > 0.5 mAmps Logic low threshold < 0.1 mAmps
Max voltage limit	30 volts
Max frequency	25 Hz
Isolation	2.5 kV RMS
Detection	Rising, falling or both edges
Soft Alarms	
Number of soft alarms	6
Alarm parameter	Any practical Modbus parameter
Alarm trip level	Any value in range
Alarm release level	Any value in range
Delay	0 to 600 seconds (10 minutes)
Output	Latched/unlatched
Other Features	
Internal temperature measurement	-20°C to +60°C
Internal temperature accuracy	± 2°C
Under/over/critical temp	User defined
Real time clock	± 2 seconds per day (1 sec intervals)
Simultaneous waveform recording	8 cycles of each phase (volts and amps)
Sub-cycle transients	Voltage and current
Resolution	0.15 ms

Integra 2270 power quality meter

Ensure error free installation and reduces wiring time by 80%

CONNECTION DIAGRAMS

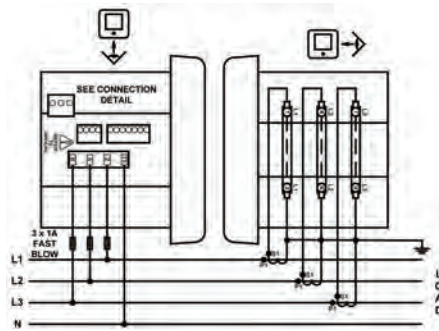

3-phase 4-wire unbalanced

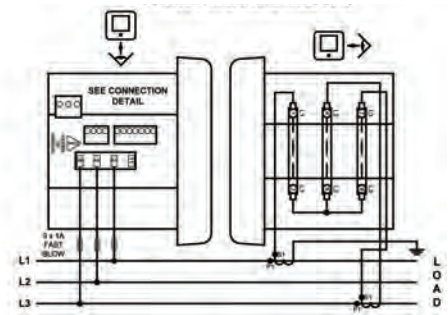

3-phase 3-wire unbalanced

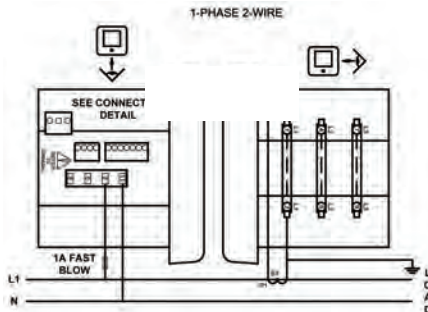

1-phase 2-wire

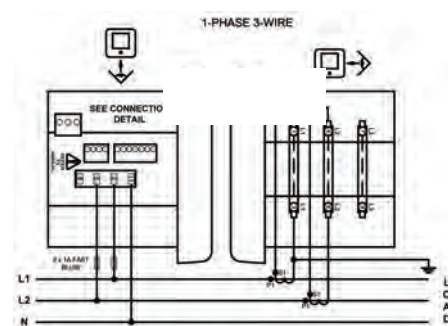

1-phase 3-wire

CONNECTION DETAIL

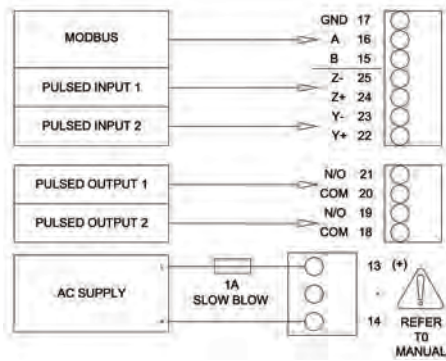



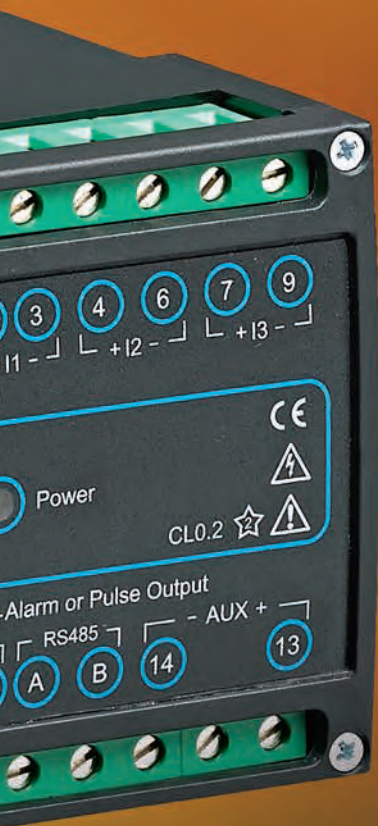

Chapter 6 Paladin advantage universal programmable transducer

Transducer - 254 XZZ.....50

Paladin advantage universal transducer

FEATURES

- DIN-rail enclosure
- Measurement, isolation and conversion of up to 4 parameters
- RS485 Modbus RTU protocol
- Alarm/pulsed output
- Programmable VT/CT ratio
- True rms measurement
- User programmable configuration



APPROVALS

- IEC 61326
- IEC 61010-1
- IEC 62053-21
- EN60688
- RoHS Compliant

BENEFITS

- Cost effective
- CL 0.2 accuracy
- EU manufactured
- Modbus communications
- Fully configurable

The Paladin Advantage, 254-XZZ, is a programmable transducer which provides measurement isolation and conversion of all main electrical parameters into an industry standard DC output signal. The 254-XZZ can be used in single and three-phase balanced or unbalanced three or four-wire electrical systems. The 254-XZZ has an accuracy of CL0.2 and includes RS485 Modbus RTU communications protocol and pulse/ alarm output as standard.

The 254-XZZ is an accurate device for the conversion of all main electrical parameters into a Voltage or mA output and provides measurement, isolation and conversion of up to four user defined inputs and outputs. The device is supplied programmed to the users requirements but can be easily be reprogrammed to suit any application.

Designed, developed and manufactured in the EU, with integrated microprocessor for exceptional waveform handling of distorted waveforms. The 254-XZZ is ideal for low, medium and high voltage applications and provides a high protection against continuous and short circuit protection as well as galvanically isolated inputs and outputs.

PRODUCT CODES

Product codes	Part number
Paladin Advantage	254-XZZ
Options	
Auxiliary	
80 – 260 V AC/DC (+/- 10%) 45 – 66 Hz, 6 VA	254-XZZ-M
20 – 60 V AC/DC (+/- 10%) 45 – 66 Hz, 6 VA	254-XZZ-L
Analogue Outputs	
Two programmable outputs	254-XZZ-*-02
Four programmable outputs	254-XZZ-*-04

DIMENSIONS

- 100 x 70 x 118 mm
- 3.94" x 3.11" x 4.65"
- Weight 0.42 kg

DIMENSIONS

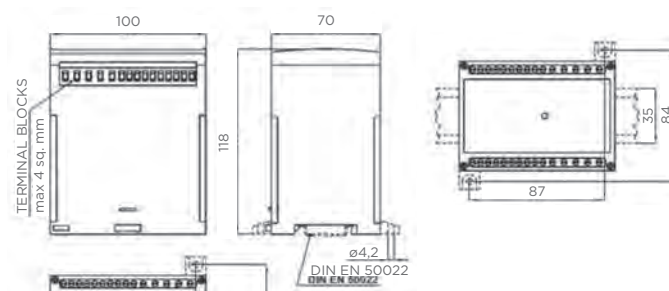

WIRING DIAGRAMS

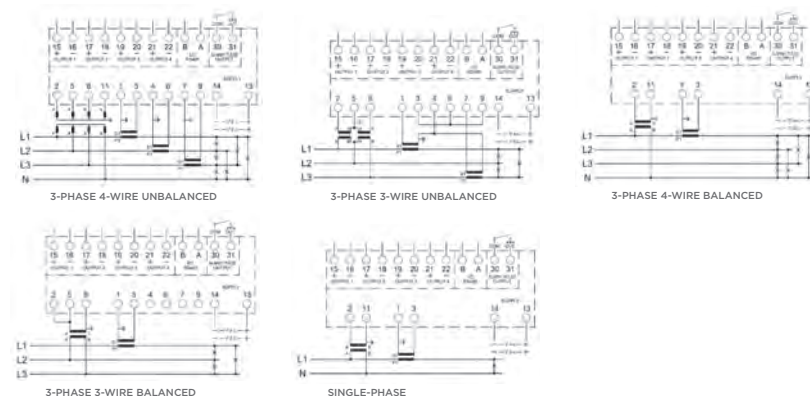

Paladin advantage universal transducer

INPUT PARAMETERS

Id	Description
VL1	Volts L1 - N
VL2	Volts L2 - N
VL3	Volts L3 - N
2VL12	Volts L1 - L2
VL23	Volts L2 - L3
VL31	Volts L3 - L1
AVG V12 V23 V31	Average Volt (L-L)
AVG V1N V2N V3N	Average Volts (L-N)
DELTA V	Volts diff L-L
DELTA VN	Volts diff L-N
IL1	Current L1
IL2	Current L2
IL3	Current L3
IN	Neutral I
AVG I1 I2 I3	Average Current
DELTA I	Current diff
I1 MAX	I1 Max demand
I2 MAX	I2 Max demand
I3 MAX	I3 Max demand
I1 AVG	Average I1
I2 AVG	Average I2
I3 AVG	Average I3
P	System power
P1	Power L1
P2	Power L2
P3	Power L3
PMAX	Max power
PAVG	Average power
Q	System VAr
Q1	System VAr L1
Q2	System VAr L2
Q3	System VAr L3
S	System VA
S1	System VA L1
S2	System VA L2
S3	System VA L3
PF	Power factor
PF AVG	Average PF
PF1	PF L1
PF2	PF L2
PF3	PF L3
SYS ANGLE	System Angle
ANGLE L1	Phase Angle L1
ANGLE L2	Phase Angle L2
ANGLE L3	Phase Angle L3
FREQ	Frequency
THDV1	THD V1
THDV2	THD V2
THDV3	THD V3
THD I1	THD I1
THD I2	THD I2
THD I3	THD I3
COSPHI 1	Displacement P.F.
COSPHI 2	Displacement P.F.
COSPHI 3	Displacement P.F.

SPECIFICATIONS

Input	
Nominal input voltage	57.7 V – 277 V AC L-N (100 – 480 V L-L) 480 V MAX
Max. continuous input overload voltage	120% of nominal
Max. short duration input voltage (300 msec)	2 x nominal voltage
Nominal input voltage burden	< 0.5 VA per phase
Nominal input current	1A AC or 5A AC rms
Nominal input current burden	< 0.1 VA
Max. continuous input overload current	2 x nominal voltage
Max. short duration input current (300 msec)	20 x nominal current
Auxiliary	
Operating range	80 – 260 V AC/DC (+/- 10%) 45 – 66 Hz, 6 VA or 20 – 60 V AC/DC (+/- 10%) 45 – 66 Hz, 6 VA
Supply burden	6 VA
Accuracy	
Voltage (V)	< 0.2%
Current (A)	< 0.2%
Neutral current calculated (A)	< 1.0%
Frequency (Hz)	< 0.1 Hz
Power factor (PF)	1% of unity
Active power (W)	+/- 0.2% of range
Reactive power (VAr)	+/- 0.2% of range
Apparent power (VA)	+/- 0.2% of range
Active energy (kWh)	Class 0.2 (IEC 62053-21)
Reactive energy (kVArh)	+/- 0.2% of range
Response time	<200 msec
Range	
Voltage (V)	5% to 120% for nominal
Current (A)	5% to 120% of nominal
Frequency	45 – 65 Hz
THD	up to 31st harmonic
Outputs	
Analogue output	0... +/- 1 mA 0... +/- 5 mA 0... +/- 10 mA 0... +/- 20 mA 4... +/- 20 mA 0... +/- 1 V 2... +/- 10 V All programmable
Pulse/alarm output relay	User defined solid state relay
Contact rating	100 mA @ 250 V
Pulse duration	30 msec to 1000 msec
Alarm delay	0 – 120 secs
Alarm hysteresis	1 – 99%
Alarm type	User Defined Solid State Relay
Communication protocol	RS485 Modbus RTU
Type	2-wire half duplex
Baud rate	9600, 19200, 38400
Enclosure	
Enclosure style	DIN-rail mounting
Dimensions	100 x 79 x 118 mm
Material	Polycarbonate to UL94-V0
Weight	0.42 kg
Terminals	Shrouded screw-clamp 0.05 – 4 mm wire
Environment	
Operating temperature	-10°C to +55°C
Storage temperature	-30°C to +70°C
Relative humidity	0 – 90% non-condensing
Shock	30 g in 3 planes
Vibration	10 Hz to 50 Hz
Dielectric voltage	Withstand test 4 kV, 50 Hz for 1 minute between auxiliary/input/output

TE Connectivity Ltd. is a \$13 billion global technology and manufacturing leader creating a safer, sustainable, productive, and connected future. For more than 75 years, our connectivity and sensor solutions, proven in the harshest environments, have enabled advancements in transportation, industrial applications, medical technology, energy, data communications, and the home. With 78,000 employees, including more than 7,000 engineers, working alongside customers in nearly 150 countries, TE ensures that EVERY CONNECTION COUNTS. - www.TE.com.

Generation

- Conventional Power
- Nuclear Power
- Wind/Solar
- Hydro-electric

Transmission & Distribution

- Substation
- Underground
- Overhead
- Street Lighting

Industry

- Mining
- Petrochemical
- Railway
- Shipbuilding

WHEREVER ELECTRICITY FLOWS, YOU'LL FIND TE ENERGY



crompton-instruments.com

FOR MORE INFORMATION:

TE Technical Support Centres

- UK: +44 1376 509 401
- USA: +1 800 327 6996
- Australia: +61 1300 656 090
- Singapore: +65 6590 5151
- Hong Kong: +852 2790 9609

te.com/energy

© 2018 TE Connectivity Ltd. family of companies. All Rights Reserved. EPP-2410-03/19

TE Connectivity, the TE connectivity (logo) and Crompton Instruments are trademarks of the TE Connectivity Ltd. family of companies. Other logos, product and Company names mentioned herein may be trademarks of their respective owners. While TE has made every reasonable effort to ensure the accuracy of the information in this brochure, TE does not guarantee that it is error-free, nor does TE make any other representation, warranty or guarantee that the information is accurate, correct, reliable or current. TE reserves the right to make any adjustments to the information contained herein at any time without notice. TE expressly disclaims all implied warranties regarding the information contained herein, including, but not limited to, any implied warranties of merchantability or fitness for a particular purpose. The dimensions in this brochure are for reference purposes only and are subject to change without notice. Specifications are subject to change without notice. Consult TE for the latest dimensions and design specifications.

